



SMSA Express - Kuwait



SLS



OPS



SSC



CSD



SFD



CORP



HRD & ADM



FIN



ITD



Kuwait - Operations



Gateway



Hub



Station

Title: Kuwait - Operations
Author: Edwin Ramos
Date: 4/13/2023
Volume: 0.00 Per Second

Authorization: Update Pending
Cost Per Second: \$,3.5,E-0317

Owner: Shaji George
Diagram Version: Draft Copy
Review Date: None
F.T.E.: 0.00

- Actions
- Change Log
- Change Requests
- Feedback
- Keywords
- Read Only



Kuwait - Station Operations



Outbound



Inbound



Fulfillment



UTL



RTS

Title: Kuwait - Station Operations
Author: Edwin Ramos
Date: 4/26/2023
Volume: 0.00 Per Second

Authorization: Update Pending
Cost Per Second: \$,3.5,E-0317

Owner: Shaji George
Diagram Version: Draft Copy
Review Date: None
F.T.E.: 0.00

- Actions
- Change Log
- Change Requests
- Feedback
- Keywords
- Read Only



Station Fulfillment Process

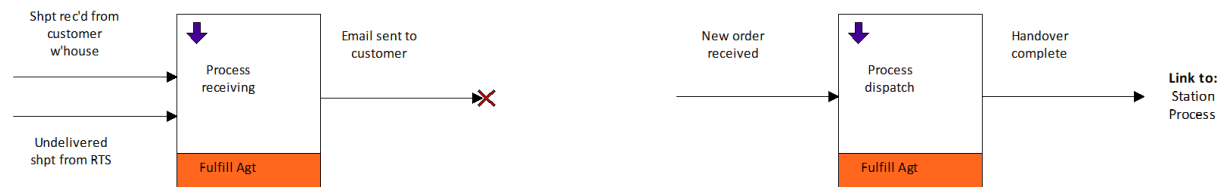

Title: Station Fulfillment Process
Author: Edwin Ramos
Date: 4/26/2023
Volume: 0.00 Per Second

Authorization: Update Pending
Cost Per Second: \$,3.5,E-0317

Owner: Shaji George
Diagram Version: Draft Copy
Review Date: None
F.T.E.: 0.00

- Actions
- Change Log
- Change Requests
- Feedback
- Keywords
- Read Only

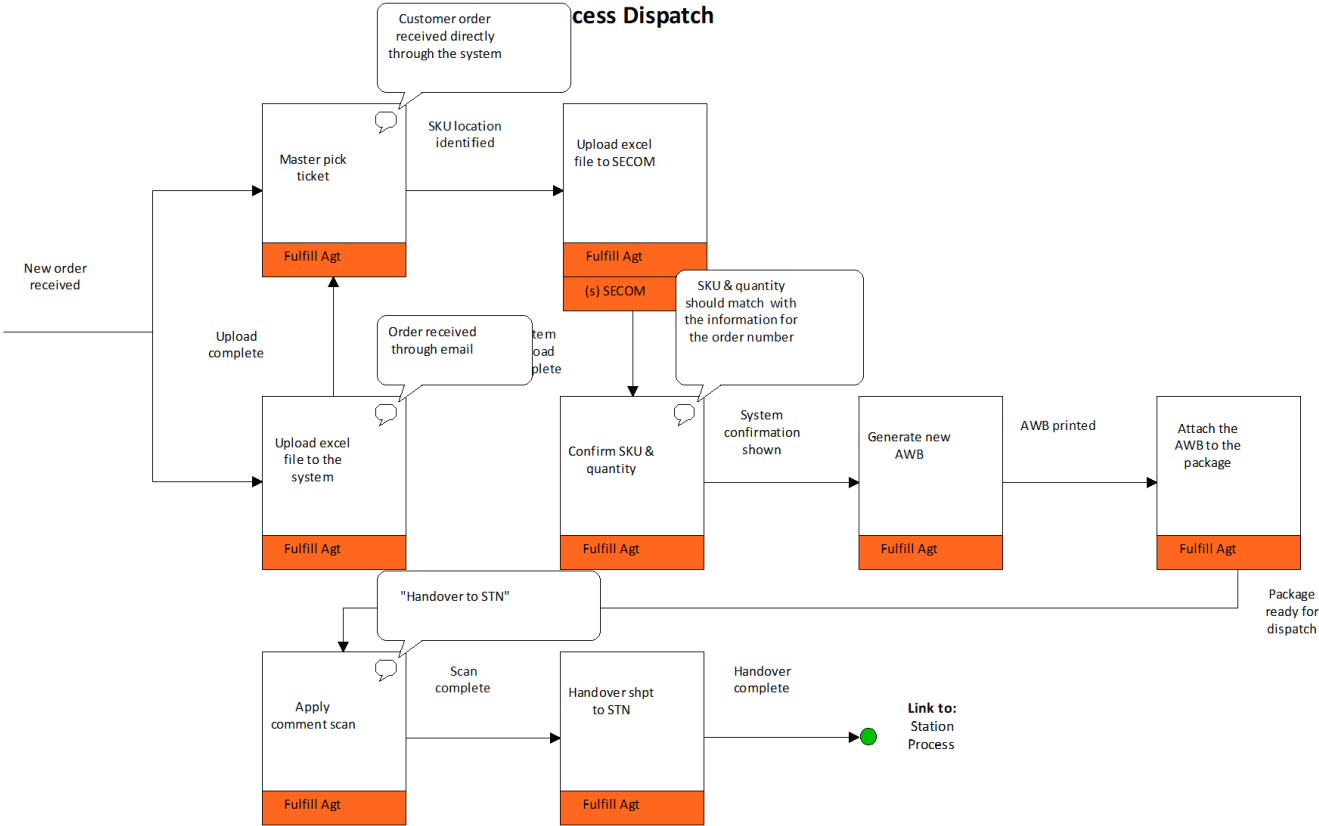

Title: Process Dispatch
 Author: Edwin Ramos
 Date: 4/8/2019
 Volume: 0.00 Per Second

Authorization: Update Pending
 Cost Per Second: \$,3.5,E-0317

Owner: Shaji George
 Diagram Version: Draft Copy
 Review Date: None
 F.T.E.: 0.00

- Actions
- Change Log
- Change Requests
- Feedback
- Keywords
- Read Only



Station UTL Process

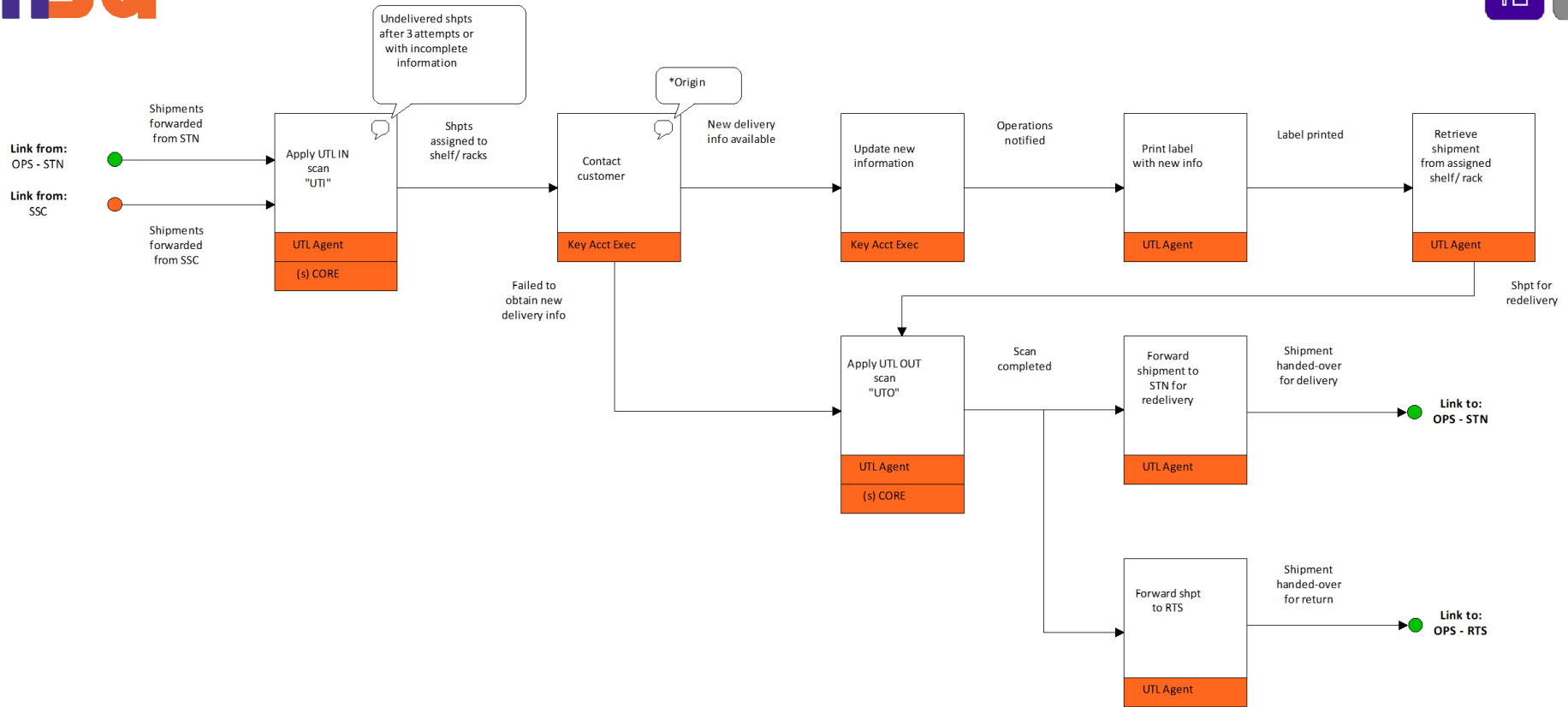



Station RTS Process

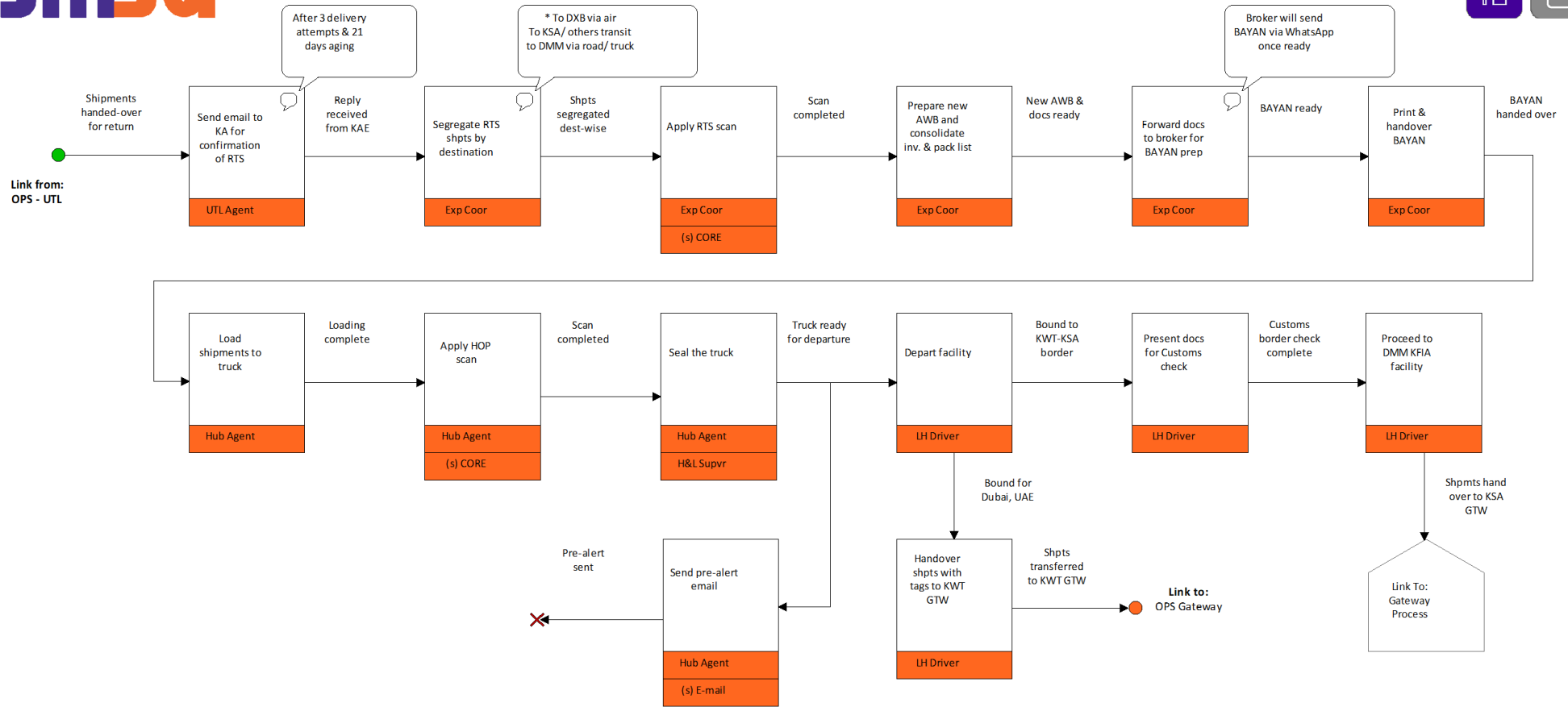

Title: Station RTS Process
 Author: Edwin Ramos
 Date: 4/26/2023
 Volume: 0.00 Per Second

Authorization: Update Pending
 Cost Per Second: \$,3.5,E-0317

Owner: Shaji George
 Diagram Version: Draft Copy
 Review Date: None
 F.T.E.: 0.00

- Actions
- Change Log
- Change Requests
- Feedback
- Keywords
- Read Only



Station Inbound Process

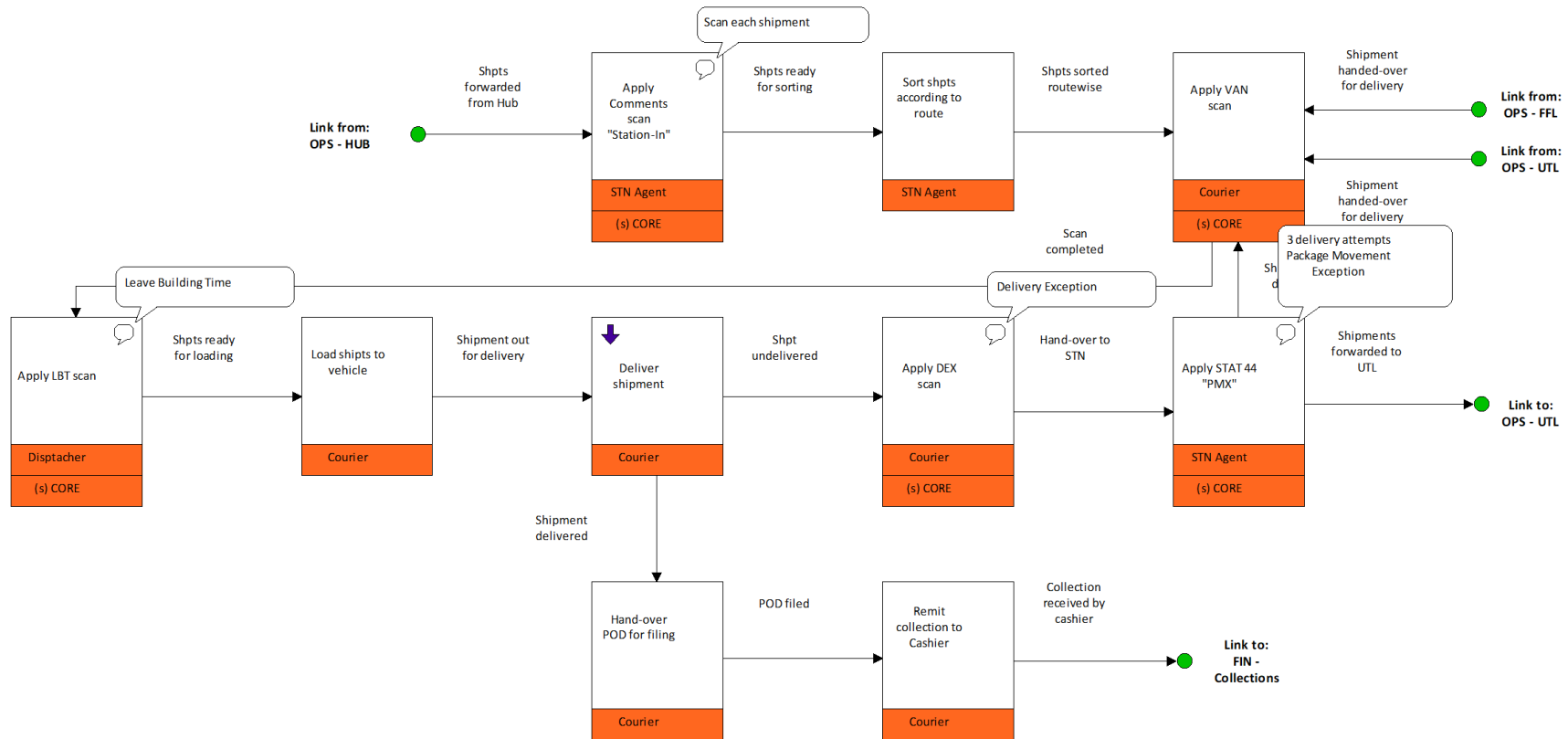

Title: Station Inbound Process
 Author: Edwin Ramos
 Date: 4/26/2023
 Volume: 0.00 Per Second

Authorization: Update Pending
 Cost Per Second: \$,3.5,E-0317

Owner: Shaji George
 Diagram Version: Draft Copy
 Review Date: None
 F.T.E.: 0.00

- Actions
- Change Log
- Change Requests
- Feedback
- Keywords
- Read Only

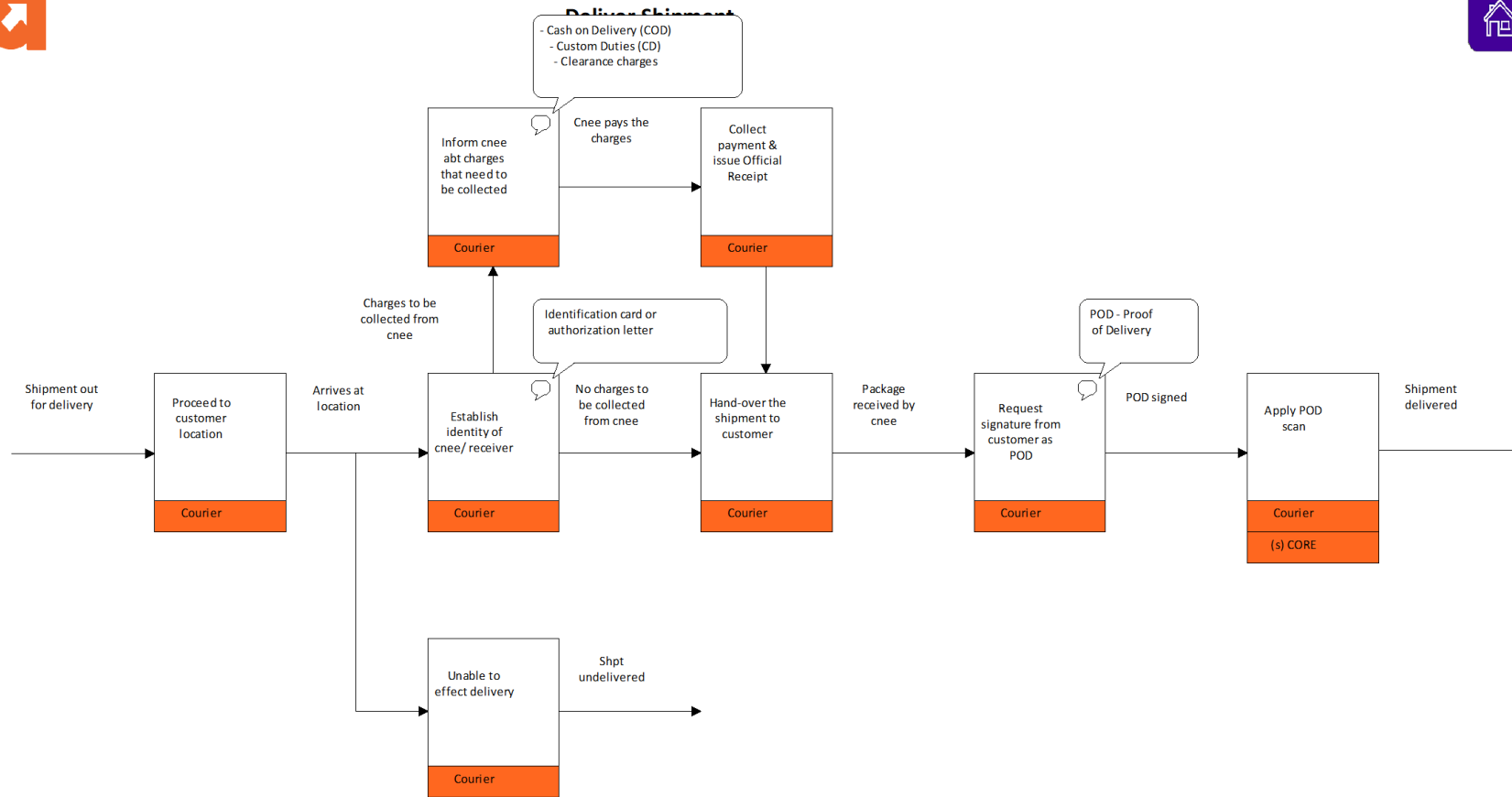

Title: Deliver Shipment
 Author: Edwin Ramos
 Date: 4/26/2023
 Volume: 0.00 Per Second

Authorization: Update Pending
 Cost Per Second: \$,3.5,E-0317

Owner: Shaji George
 Diagram Version: Draft Copy
 Review Date: None
 F.T.E.: 0.00

- Actions
- Change Log
- Change Requests
- Feedback
- Keywords
- Read Only



Station Outbound Process

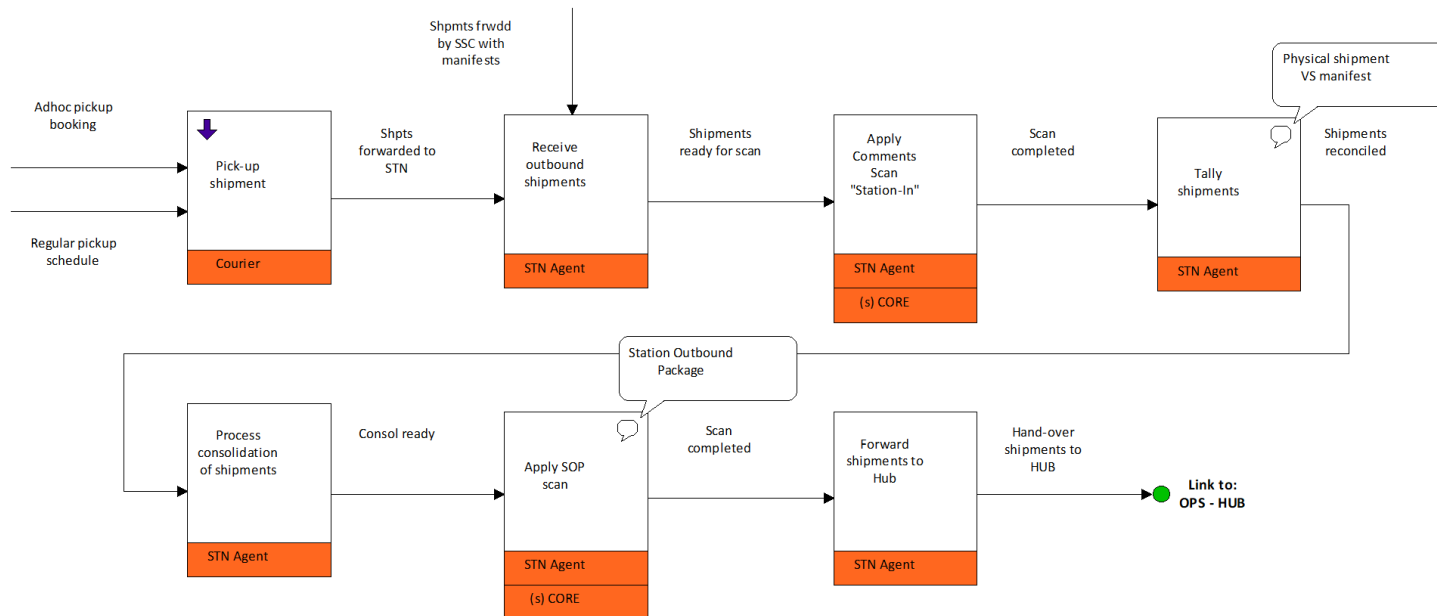

Title: Station Outbound Process
 Author: Edwin Ramos
 Date: 4/26/2023
 Volume: 0.00 Per Second

Authorization: Update Pending
 Cost Per Second: \$,3.5,E-0317

Owner: Shaji George
 Diagram Version: Draft Copy
 Review Date: None
 F.T.E.: 0.00

- Actions
- Change Log
- Change Requests
- Feedback
- Keywords
- Read Only



Pick-up shipment

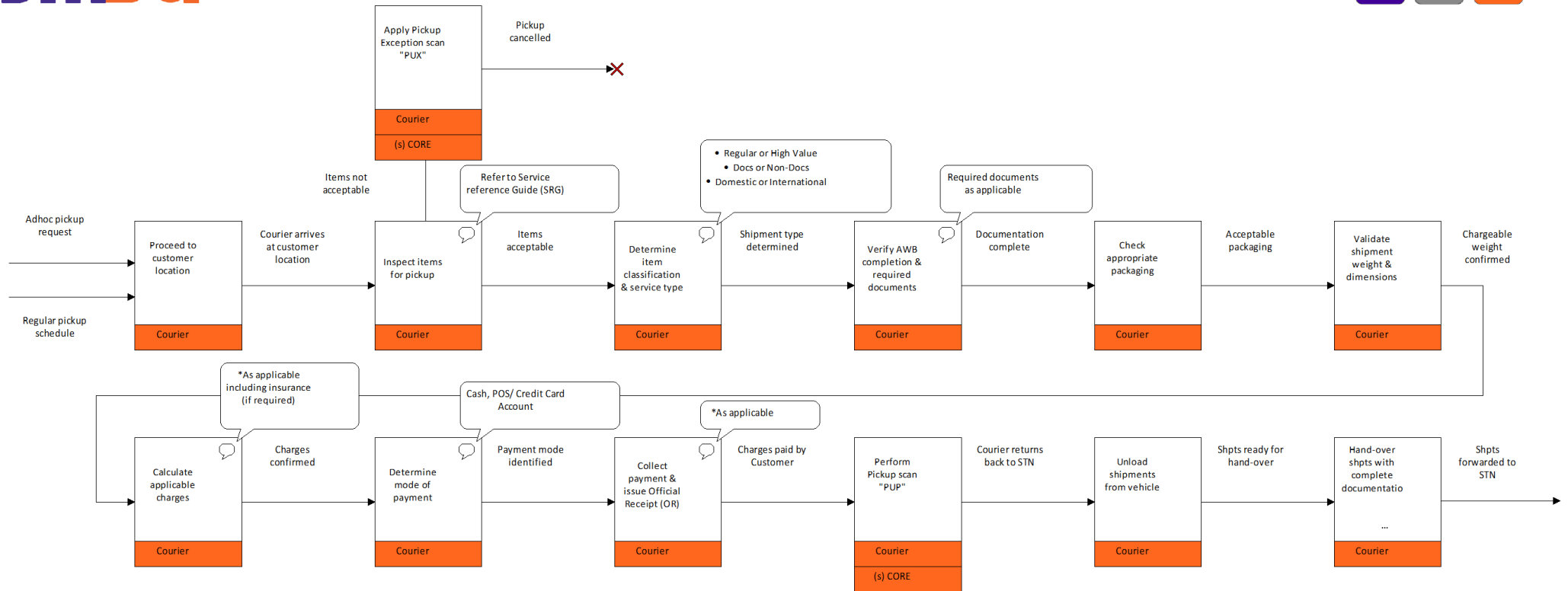

Title: Pick-up shipment
 Author: Edwin Ramos
 Date: 5/2/2023
 Volume: 0.00 Per Second

Authorization: Update Pending
 Cost Per Second: \$,3.5,E-0317

Owner: Shaji George
 Diagram Version: Draft Copy
 Review Date: None
 F.T.E.: 0.00

○ Actions ○ Feedback
 ● Change Log ○ Keywords
 ○ Change Requests ○ Read Only



Gateway Inbound Process

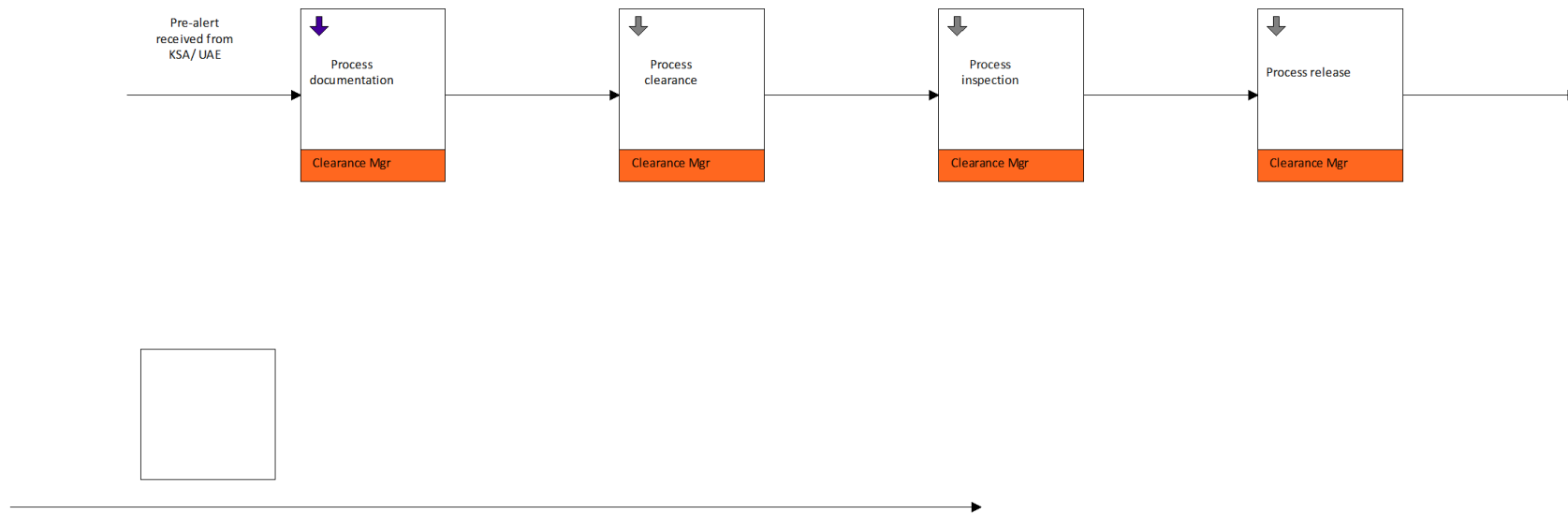

Title: Gateway Inbound Process
Author: Edwin Ramos
Date: 5/7/2023
Volume: 0.00 Per Second

Authorization: Update Pending
Cost Per Second: \$,3.5,E-0317

Owner: Shaji George
Diagram Version: Draft Copy
Review Date: None
F.T.E.: 0.00

- Actions
- Change Log
- Change Requests
- Feedback
- Keywords
- Read Only



Documentation Process

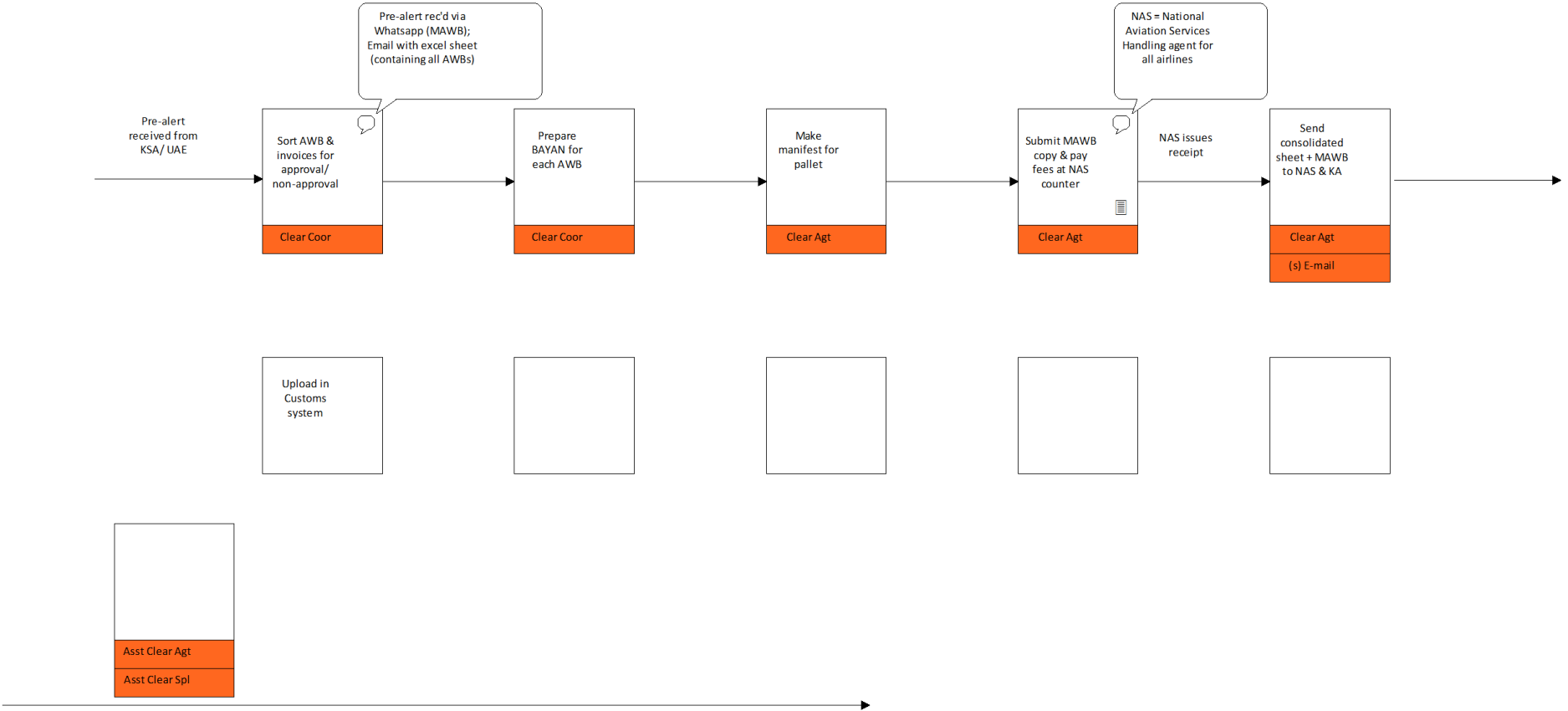



Process clearance

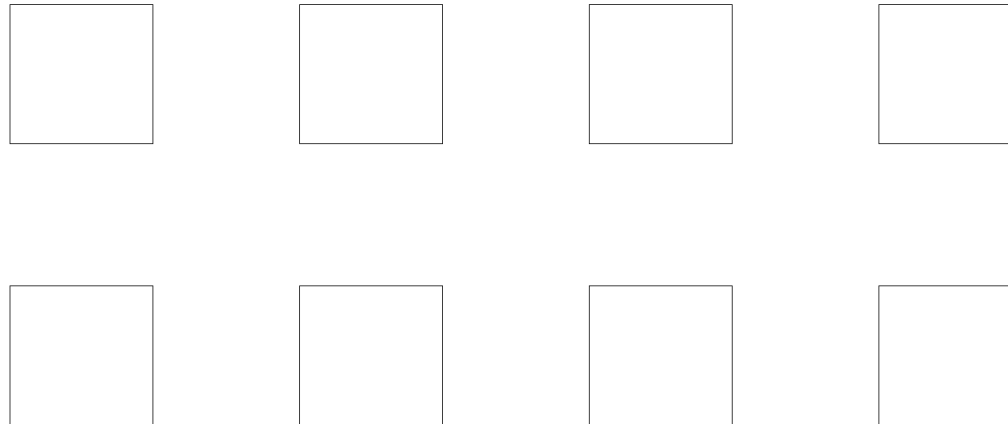

Title: Process clearance
Author: Edwin Ramos
Date: 6/29/2025
Volume: 0.00 Per Second

Authorization: Update Pending
Cost Per Second: \$,3.5,E-0317

Owner: Edwin Ramos
Diagram Version: Draft Copy
Review Date: None
F.T.E.: 0.00

- Actions
- Change Log
- Change Requests
- Feedback
- Keywords
- Read Only



Process inspection

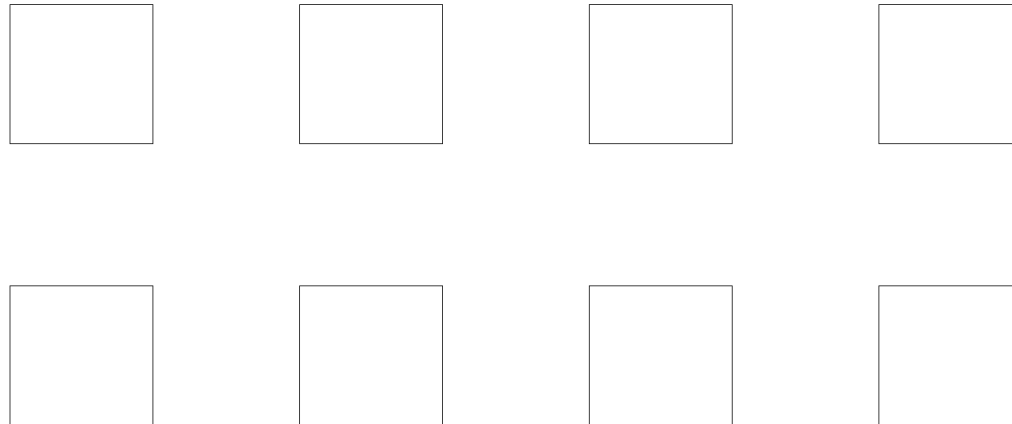

Title: Process inspection
Author: Edwin Ramos
Date: 6/29/2025
Volume: 0.00 Per Second

Authorization: Update Pending
Cost Per Second: \$,3.5,E-0317

Owner: Edwin Ramos
Diagram Version: Draft Copy
Review Date: None
F.T.E.: 0.00

- Actions
- Feedback
- Change Log
- Keywords
- Change Requests
- Read Only



Process release

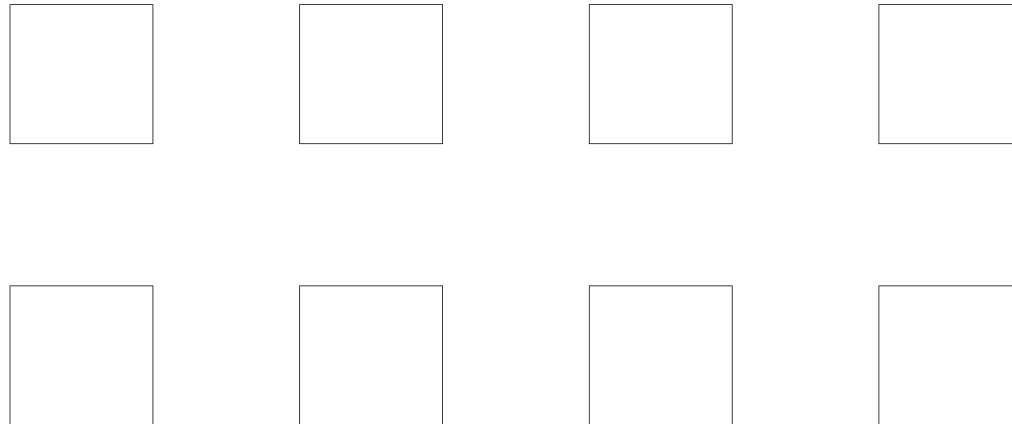

Title: Process release
Author: Edwin Ramos
Date: 6/29/2025
Volume: 0.00 Per Second

Authorization: Update Pending
Cost Per Second: \$,3.5,E-0317

Owner: Edwin Ramos
Diagram Version: Draft Copy
Review Date: None
F.T.E.: 0.00

- Actions
- Change Log
- Change Requests
- Feedback
- Keywords
- Read Only



Gateway Outbound Process

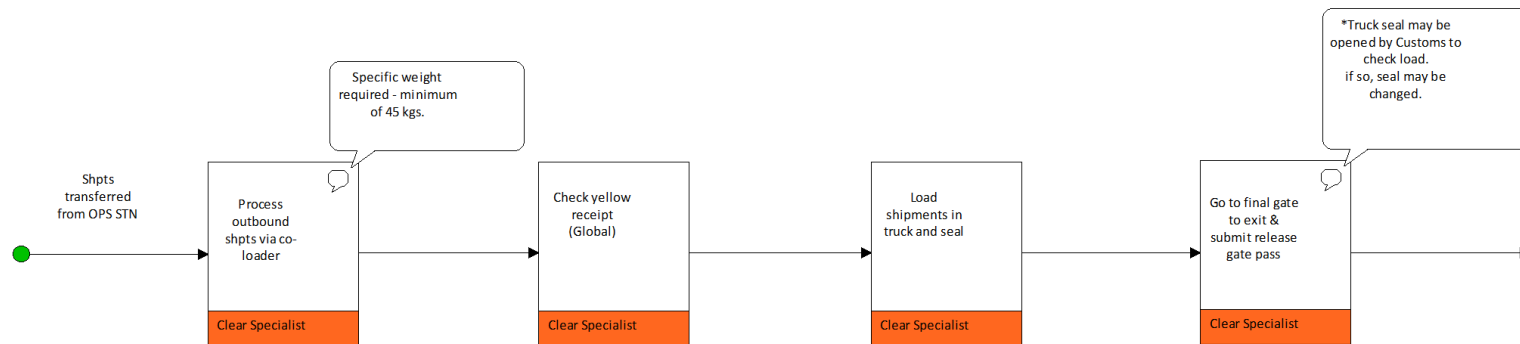

Title: Gateway Outbound Process
Author: Edwin Ramos
Date: 5/7/2023
Volume: 0.00 Per Second

Authorization: Update Pending
Cost Per Second: \$,3.5,E-0317

Owner: Shaji George
Diagram Version: Draft Copy
Review Date: None
F.T.E.: 0.00

- Actions
- Change Log
- Change Requests
- Feedback
- Keywords
- Read Only



Kuwait - Hub Operations

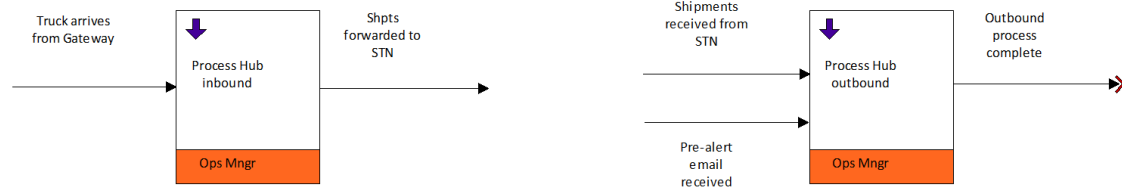

Title: Kuwait - Hub Operations
Author: Edwin Ramos
Date: 4/26/2023
Volume: 0.00 Per Second

Authorization: Update Pending
Cost Per Second: \$,3.5,E-0317

Owner: Shaji George
Diagram Version: Draft Copy
Review Date: None
F.T.E.: 0.00

- Actions
- Change Log
- Change Requests
- Feedback
- Keywords
- Read Only



Hub Inbound Process

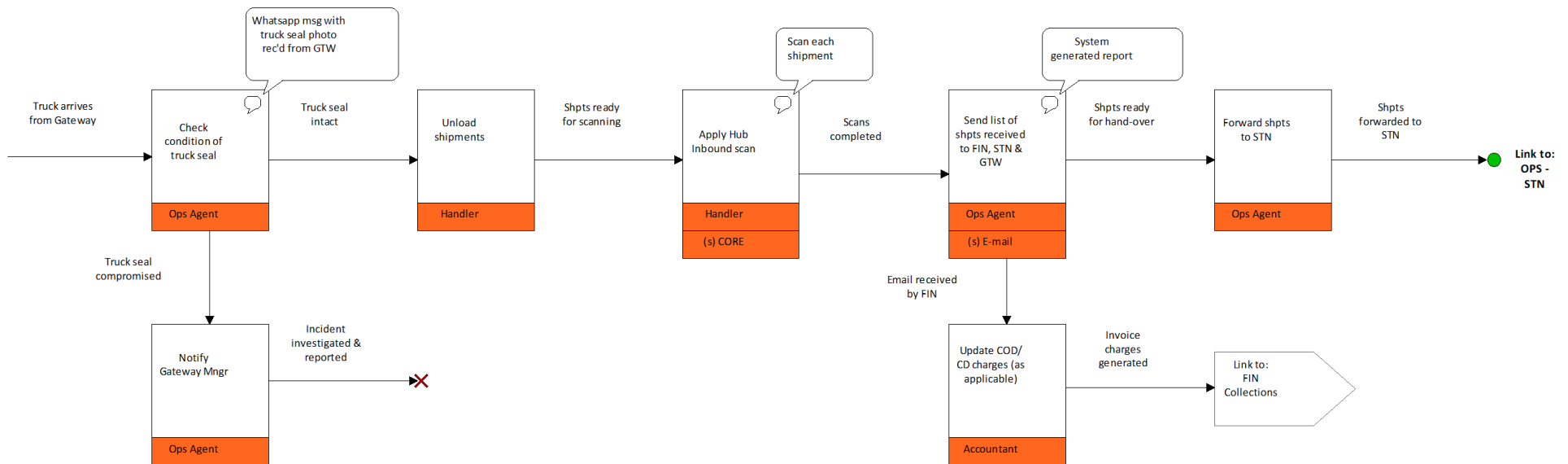

Title: Hub Inbound Process
 Author: Edwin Ramos
 Date: 4/26/2023
 Volume: 0.00 Per Second

Authorization: Update Pending
 Cost Per Second: \$,3.5,E-0317

Owner: Shaji George
 Diagram Version: Draft Copy
 Review Date: None
 F.T.E.: 0.00

- Actions
- Change Log
- Change Requests
- Feedback
- Keywords
- Read Only



Hub Outbound Process

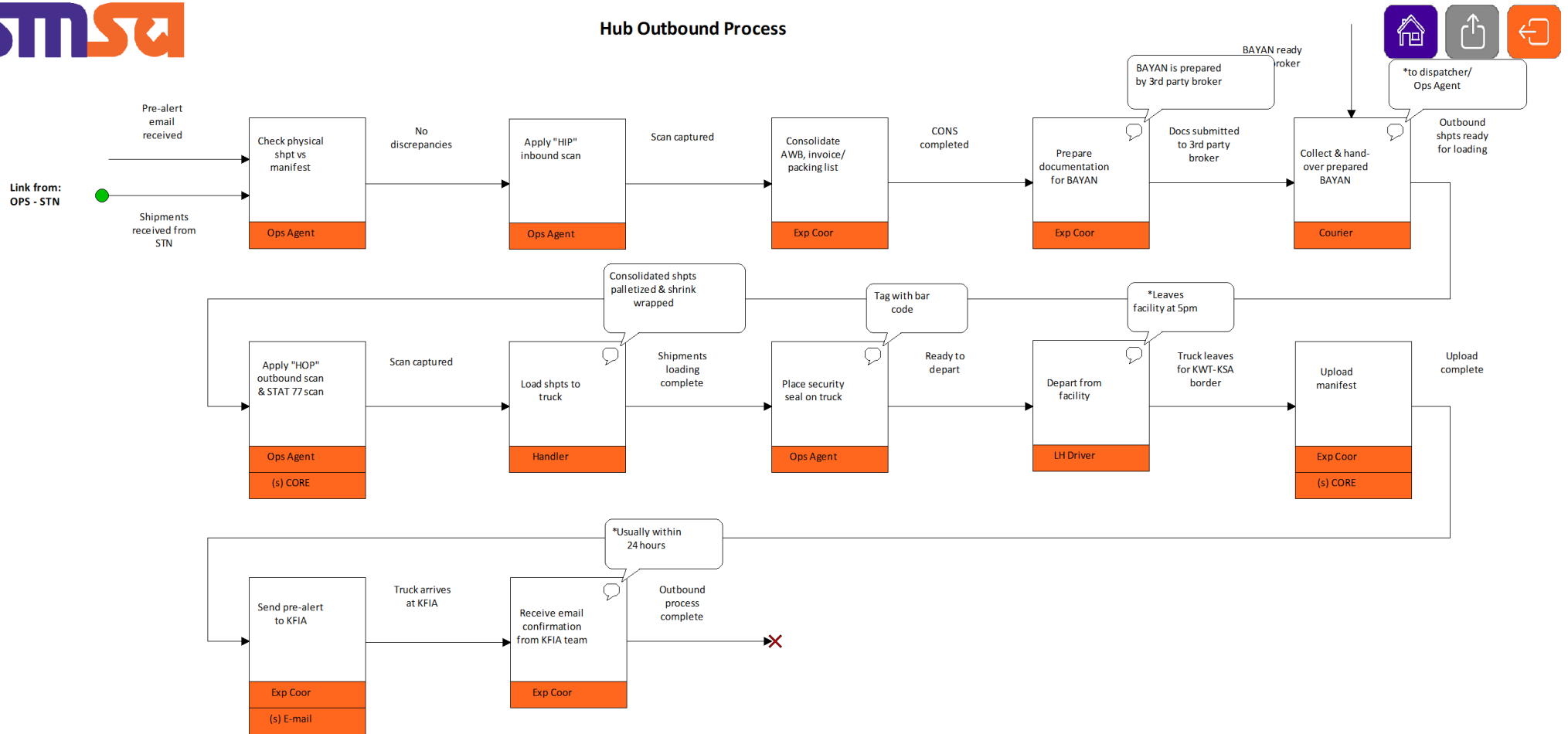

Title: Hub Outbound Process
 Author: Edwin Ramos
 Date: 4/26/2023
 Volume: 0.00 Per Second

Authorization: Update Pending
 Cost Per Second: \$,3.5,E-0317

Owner: Shaji George
 Diagram Version: Draft Copy
 Review Date: None
 F.T.E.: 0.00

- Actions
- Change Log
- Change Requests
- Feedback
- Keywords
- Read Only



Kuwait - Service Centers

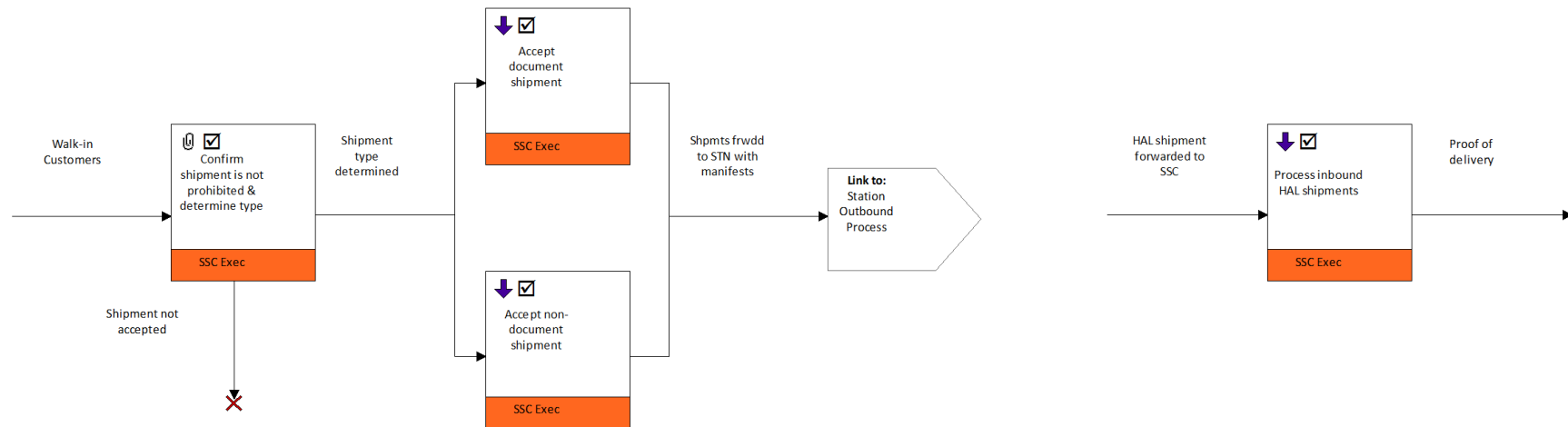

Title: Kuwait - Service Centers
 Author: Edwin Ramos
 Date: 4/13/2023
 Volume: 0.00 Per Second

Authorization: Update Pending
 Cost Per Second: \$,3.5,E-0317

Owner: Shaji George
 Diagram Version: Draft Copy
 Review Date: None
 F.T.E.: 0.00

- Actions
- Change Log
- Change Requests
- Feedback
- Keywords
- Read Only



Accept Document Shipment

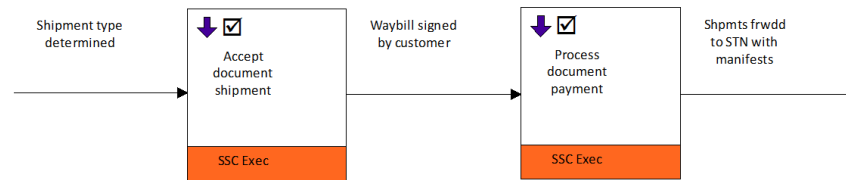

Title: Accept Document Shipment
Author: Edwin Ramos
Date: 8/8/2020
Volume: 0.00 Per Second

Authorization: Update Pending
Cost Per Second: \$,3.5,E-0317

Owner: Shaji George
Diagram Version: Draft Copy
Review Date: None
F.T.E.: 0.00

- Actions
- Feedback
- Change Log
- Keywords
- Change Requests
- Read Only



Accept Document Shipment

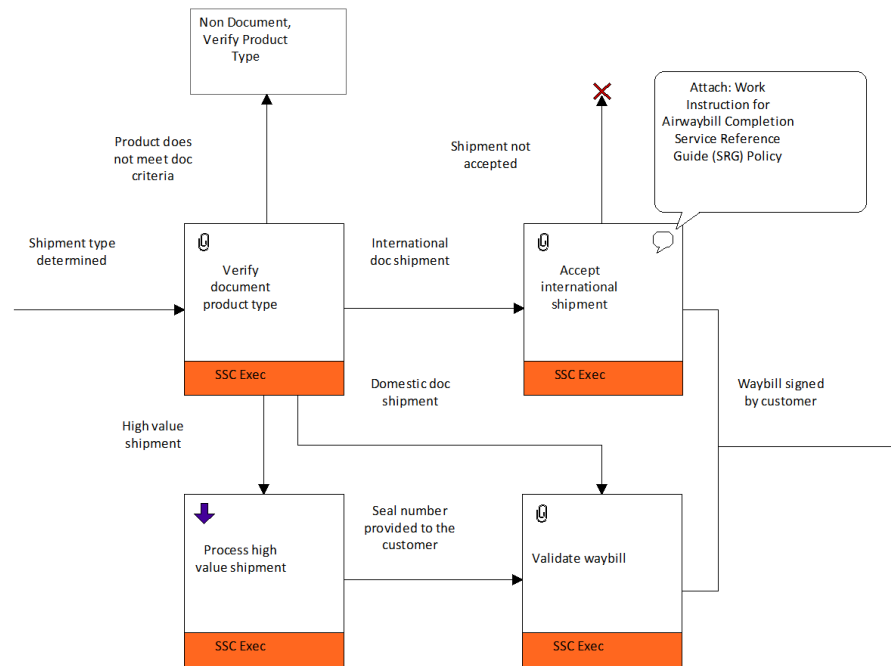

Title: Accept Document Shipment
 Author: Edwin Ramos
 Date: 8/8/2020
 Volume: 0.00 Per Second

Authorization: Update Pending
 Cost Per Second: \$,3.5,E-0317

Owner: Shaji George
 Diagram Version: Draft Copy
 Review Date: None
 F.T.E.: 0.00

- Actions
- Change Log
- Change Requests
- Feedback
- Keywords
- Read Only



Process High Value Shipment

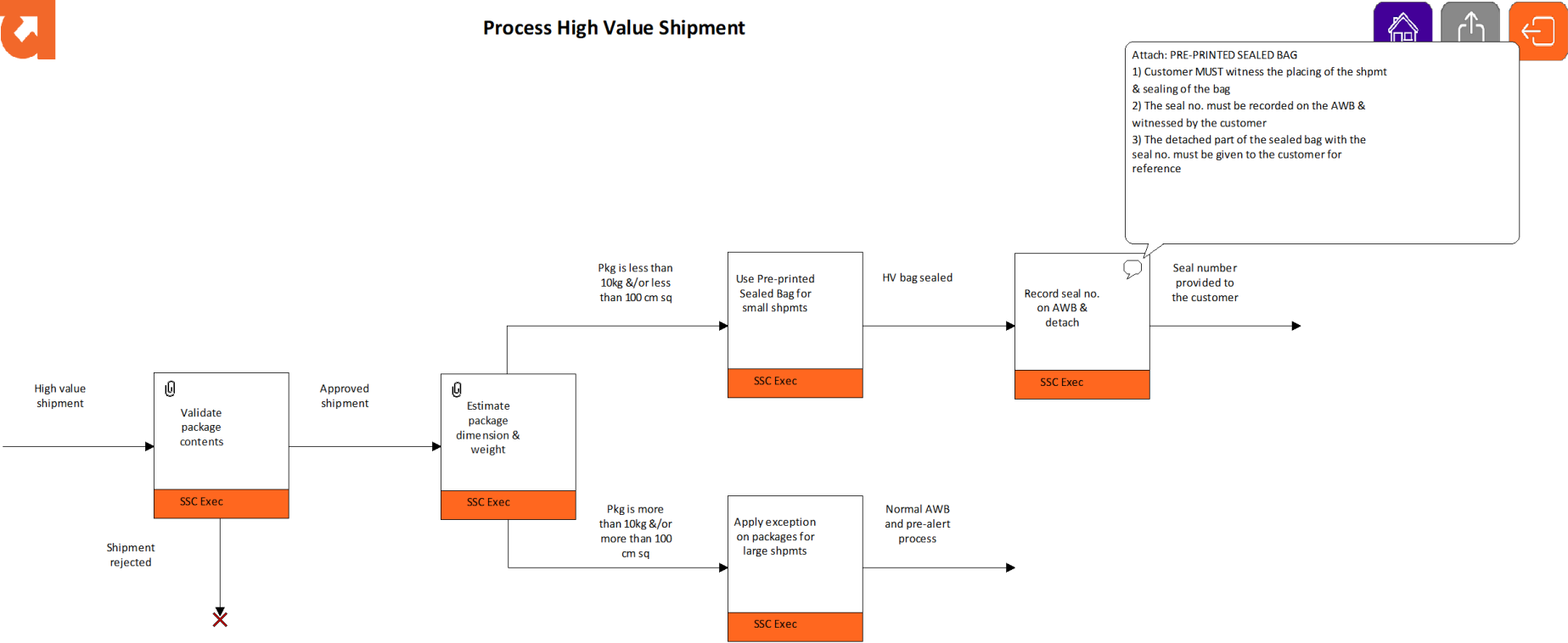

Title: Process High Value Shipment
 Author: Edwin Ramos
 Date: 8/8/2020
 Volume: 0.00 Per Second

Authorization: Update Pending
 Cost Per Second: \$,3.5,E-0317

Owner: Shaji George
 Diagram Version: Draft Copy
 Review Date: None
 F.T.E.: 0.00

- Actions
- Change Log
- Change Requests
- Feedback
- Keywords
- Read Only

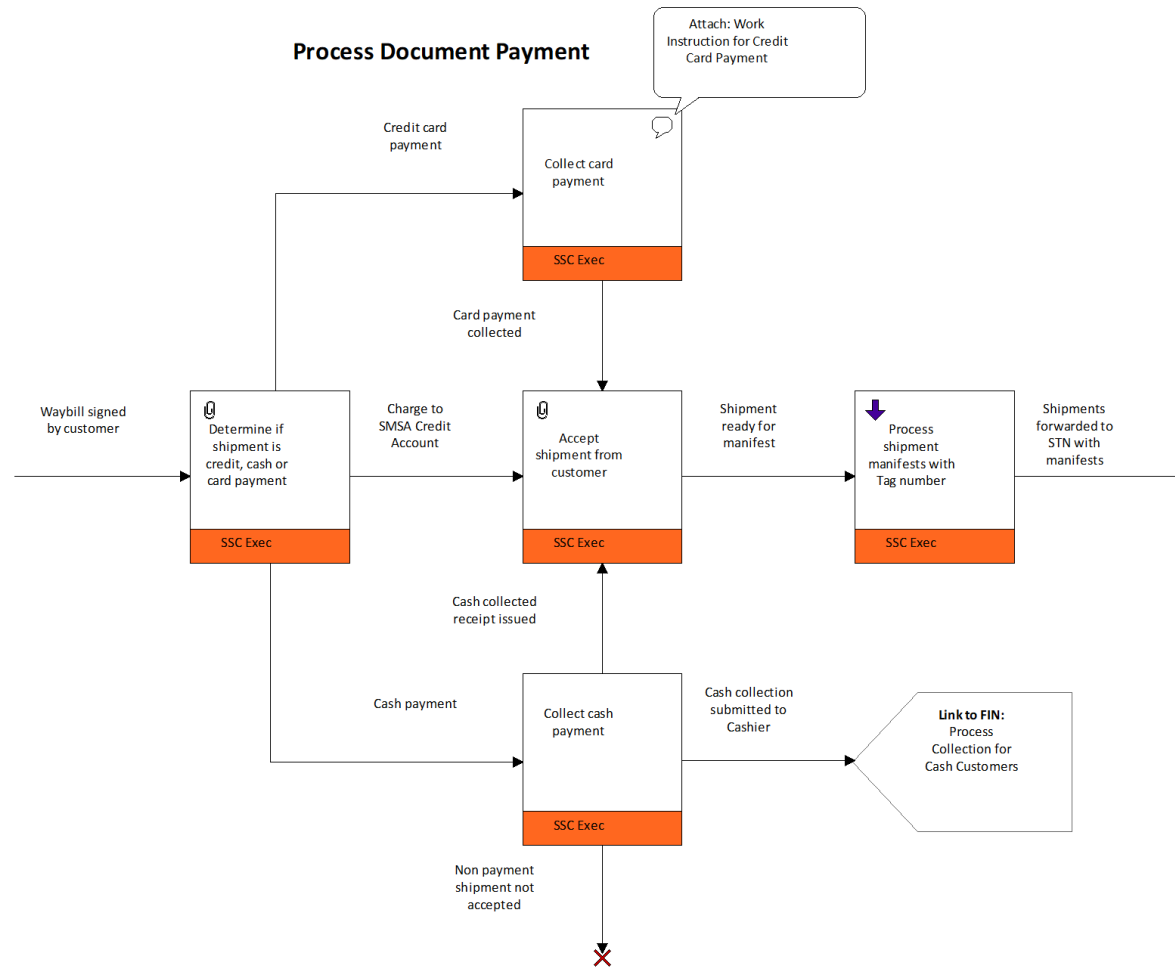

Title: Process Document Payment
 Author: Edwin Ramos
 Date: 8/8/2020
 Volume: 0.00 Per Second

Authorization: Update Pending
 Cost Per Second: \$,3.5,E-0317

Owner: Shaji George
 Diagram Version: Draft Copy
 Review Date: None
 F.T.E.: 0.00

- Actions
- Change Log
- Change Requests
- Feedback
- Keywords
- Read Only



Process Shipment Manifest

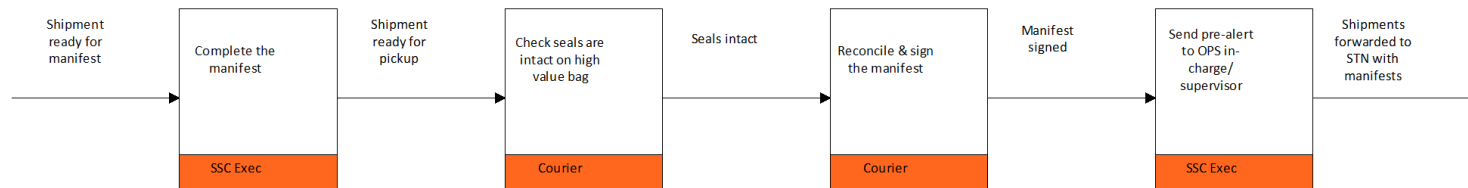

Title: Process Shipment Manifest
Author: Edwin Ramos
Date: 8/8/2020
Volume: 0.00 Per Second

Authorization: Update Pending
Cost Per Second: \$,3.5,E-0317

Owner: Shaji George
Diagram Version: Draft Copy
Review Date: None
F.T.E.: 0.00

- Actions
- Feedback
- Change Log
- Keywords
- Change Requests
- Read Only



Accept Non-Document Shipment

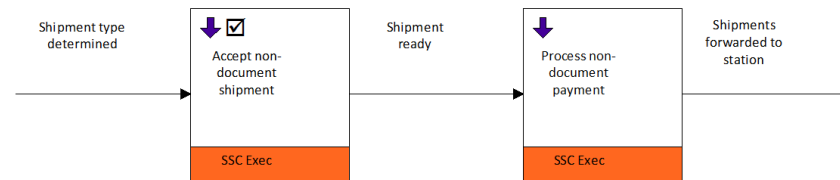

Title: Accept Non-Document Shipment
Author: Edwin Ramos
Date: 8/8/2020
Volume: 0.00 Per Second
Authorization: Update Pending
Cost Per Second: \$,3.5,E-0317

Owner: Shaji George
Diagram Version: Draft Copy
Review Date: None
F.T.E.: 0.00

- Actions
- Change Log
- Change Requests
- Feedback
- Keywords
- Read Only

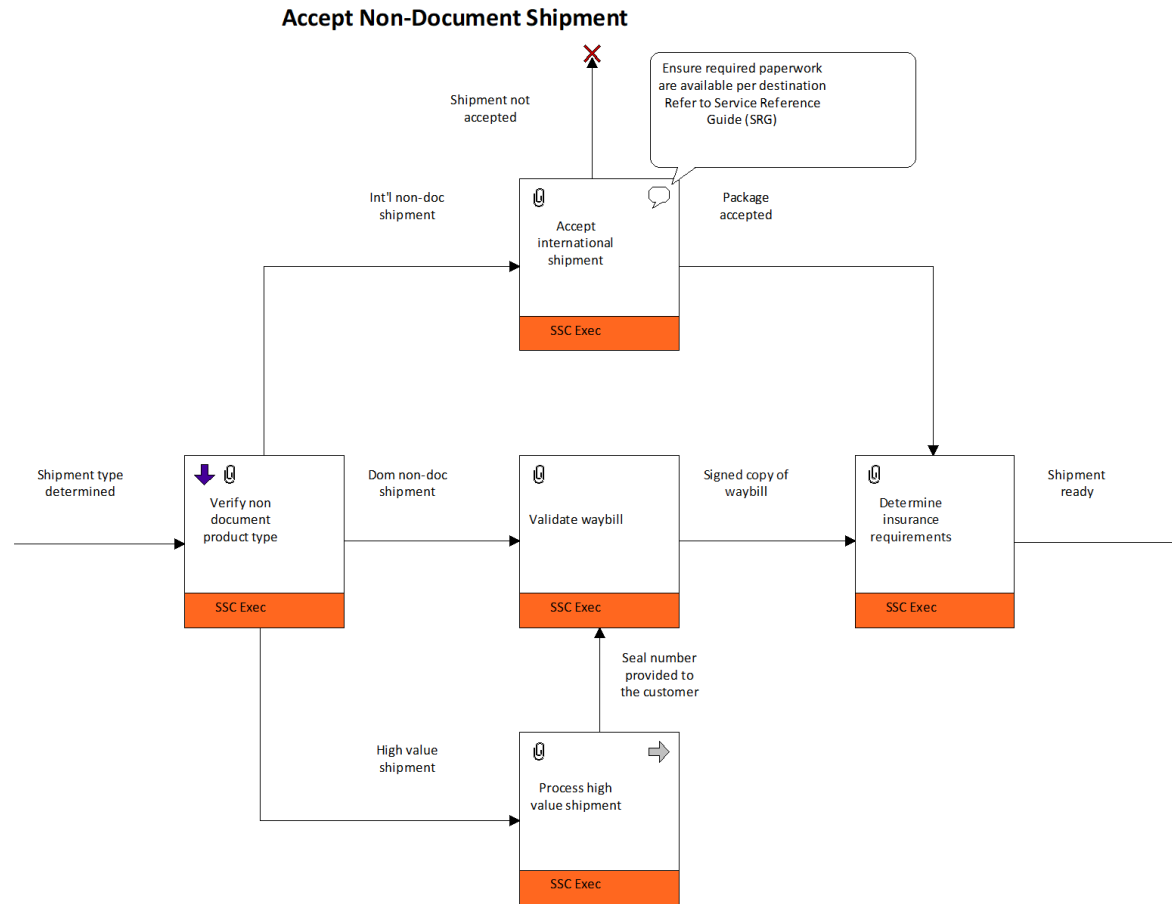

Title: Accept Non-Document Shipment
 Author: Edwin Ramos
 Date: 8/8/2020
 Volume: 0.00 Per Second

Authorization: Update Pending
 Cost Per Second: \$,3.5,E-0317

Owner: Shaji George
 Diagram Version: Draft Copy
 Review Date: None
 F.T.E.: 0.00

- Actions
- Change Log
- Change Requests
- Feedback
- Keywords
- Read Only



Verify Non Document Product Type

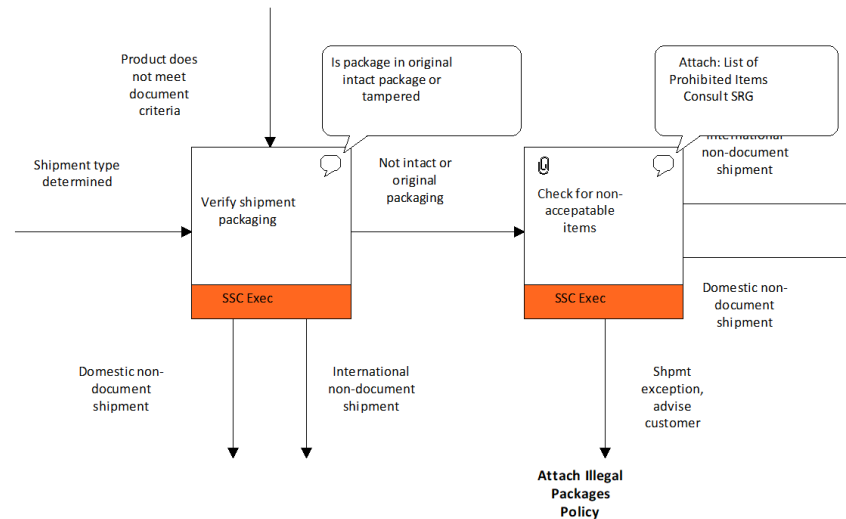

Title: Verify Non Document Product Type
 Author: Edwin Ramos
 Date: 8/8/2020
 Volume: 0.00 Per Second

Authorization: Update Pending
 Cost Per Second: \$,3.5,E-0317

Owner: Shaji George
 Diagram Version: Draft Copy
 Review Date: None
 F.T.E.: 0.00

- Actions
- Change Log
- Change Requests
- Feedback
- Keywords
- Read Only

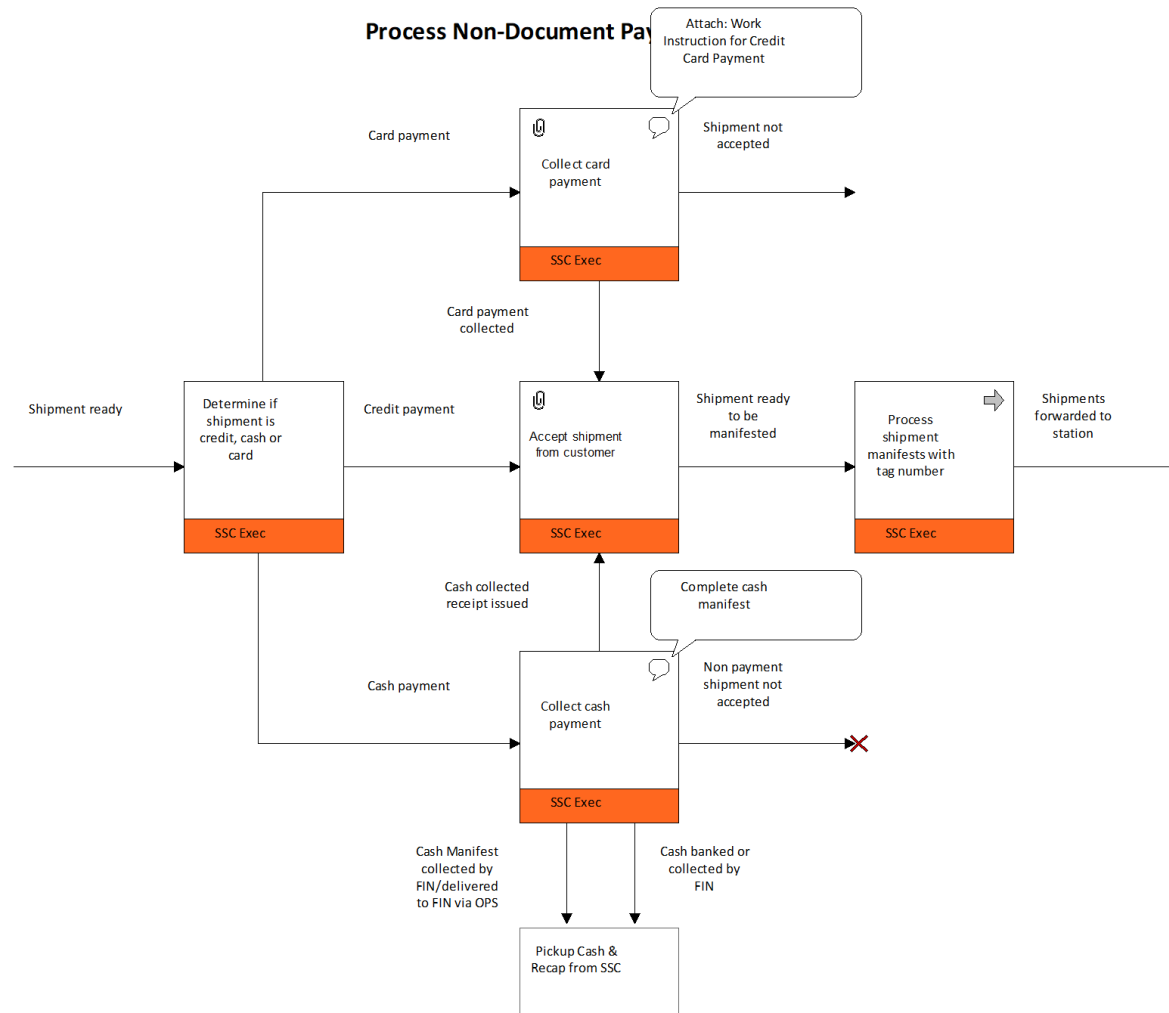

Title: Process Non-Document Payment
 Author: Edwin Ramos
 Date: 8/8/2020
 Volume: 0.00 Per Second
 Authorization: Update Pending
 Cost Per Second: \$,3.5,E-0317

Owner: Shaji George
 Diagram Version: Draft Copy
 Review Date: None
 F.T.E.: 0.00

- Actions
- Change Log
- Change Requests
- Feedback
- Keywords
- Read Only



Process Inbound HAL Shipments

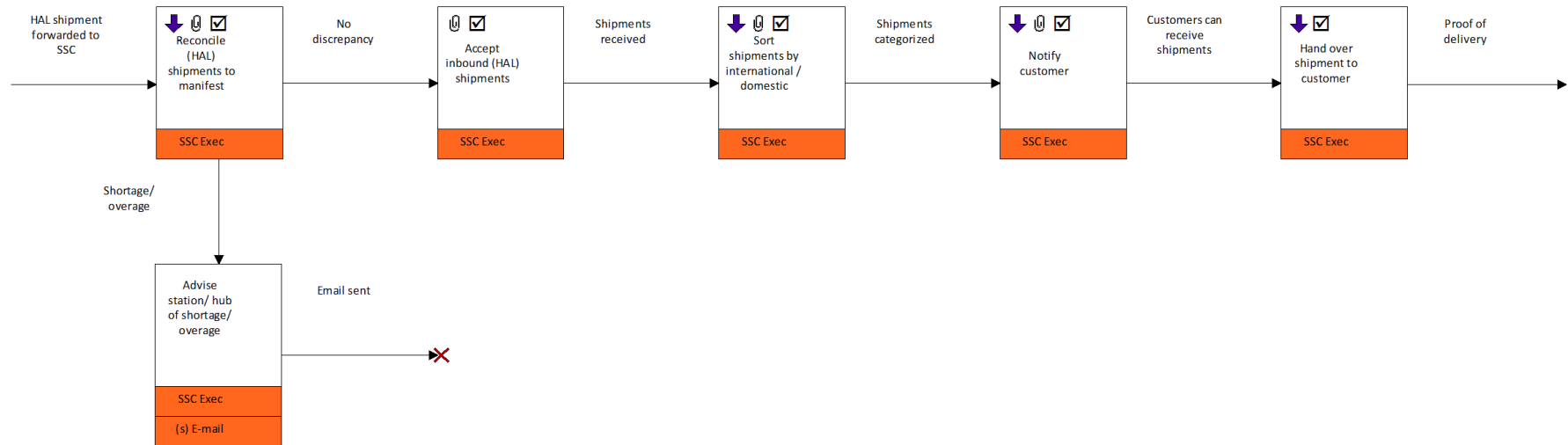



Reconcile (HAL) Shipments to Manifest

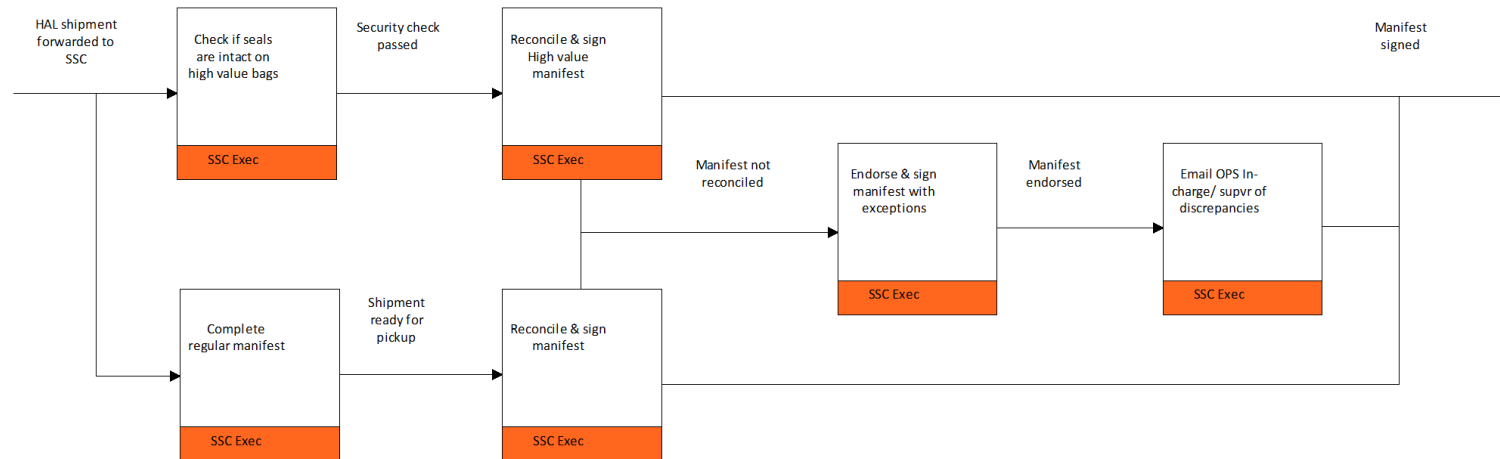



Sort Shipments by International/ Domestic

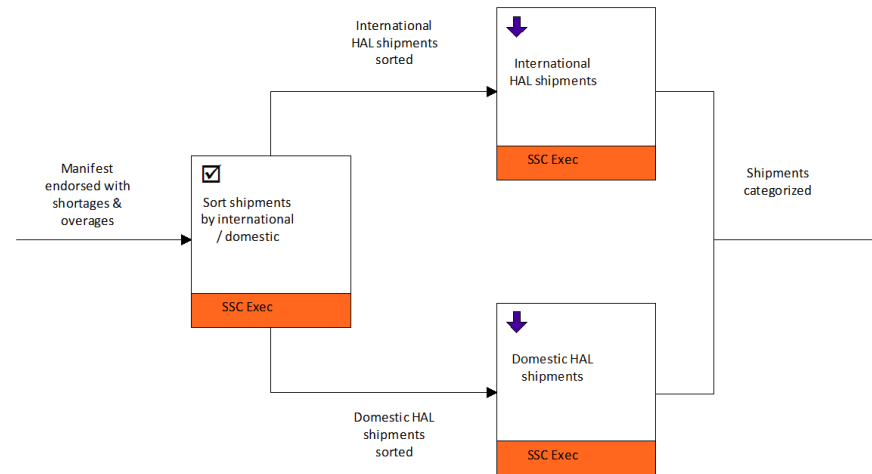

Title: Sort Shipments by International/ Domestic
Author: Edwin Ramos Authorization: Update Pending
Date: 8/8/2020
Volume: 0.00 Per Second Cost Per Second: \$,3.5,E-0317

Owner: Shaji George
Diagram Version: Draft Copy
Review Date: None
F.T.E.: 0.00

- Actions
- Feedback
- Change Log
- Keywords
- Change Requests
- Read Only

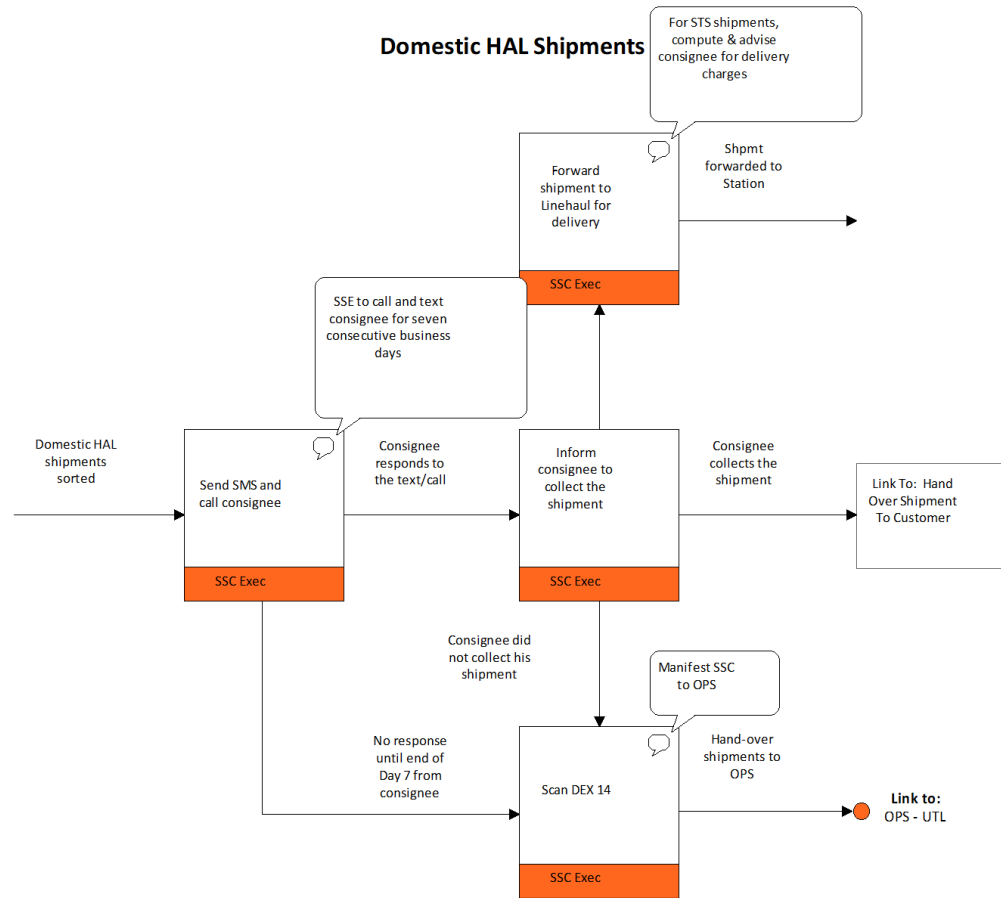

Title: Domestic HAL Shipments
 Author: Edwin Ramos
 Date: 8/8/2020
 Volume: 0.00 Per Second

Authorization: Update Pending
 Cost Per Second: \$,3.5,E-0317

Owner: Shaji George
 Diagram Version: Draft Copy
 Review Date: None
 F.T.E.: 0.00

- Actions
- Change Log
- Change Requests
- Feedback
- Keywords
- Read Only



Notify Customer

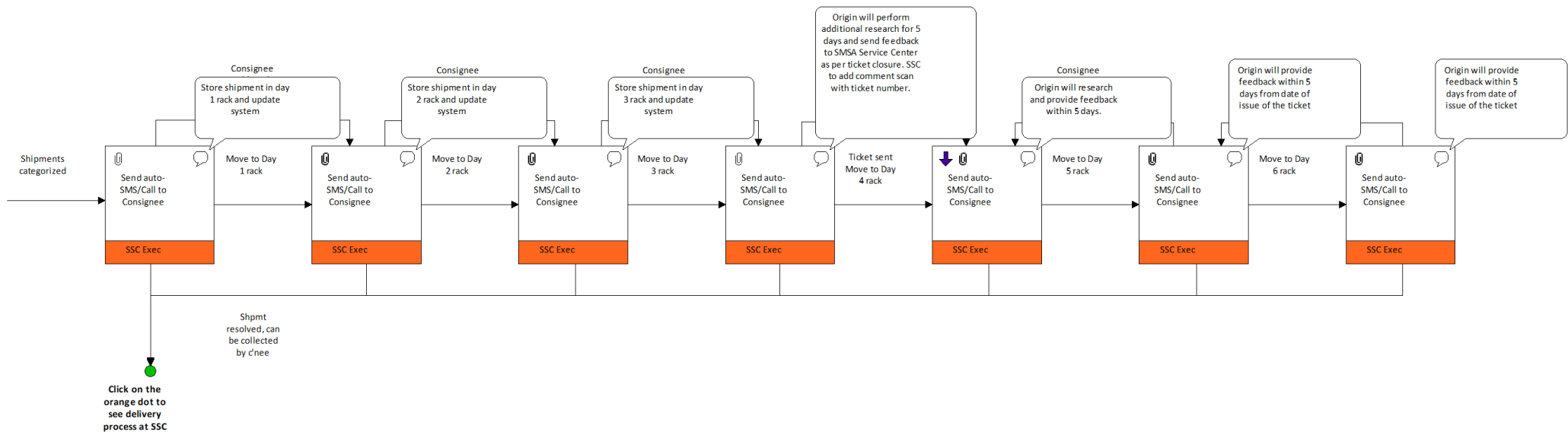

Title: Notify Customer
 Author: Edwin Ramos
 Date: 8/8/2020
 Volume: 0.00 Per Second

Authorization: Update Pending
 Cost Per Second: \$,3.5,E-0317

Owner: Shaji George
 Diagram Version: Draft Copy
 Review Date: None
 F.T.E.: 0.00

○ Actions ○ Feedback
 ● Change Log ● Keywords
 ● Change Requests ○ Read Only



Receive Feedback from Origin

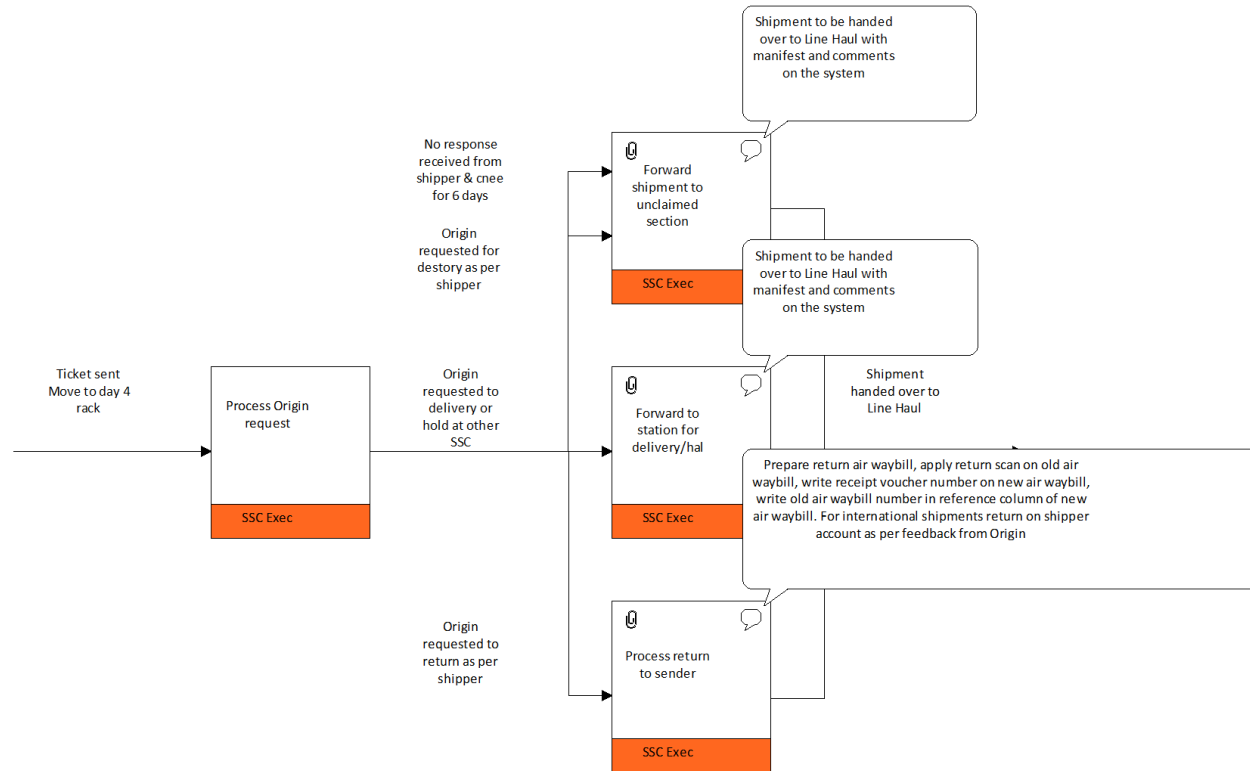

Title: Receive Feedback from Origin
 Author: Edwin Ramos
 Date: 8/8/2020
 Volume: 0.00 Per Second
 Authorization: Update Pending
 Cost Per Second: \$,3.5,E-0317

Owner: Shaji George
 Diagram Version: Draft Copy
 Review Date: None
 F.T.E.: 0.00

- Actions
- Change Log
- Change Requests
- Feedback
- Keywords
- Read Only



Hand-over Shipment to Customer

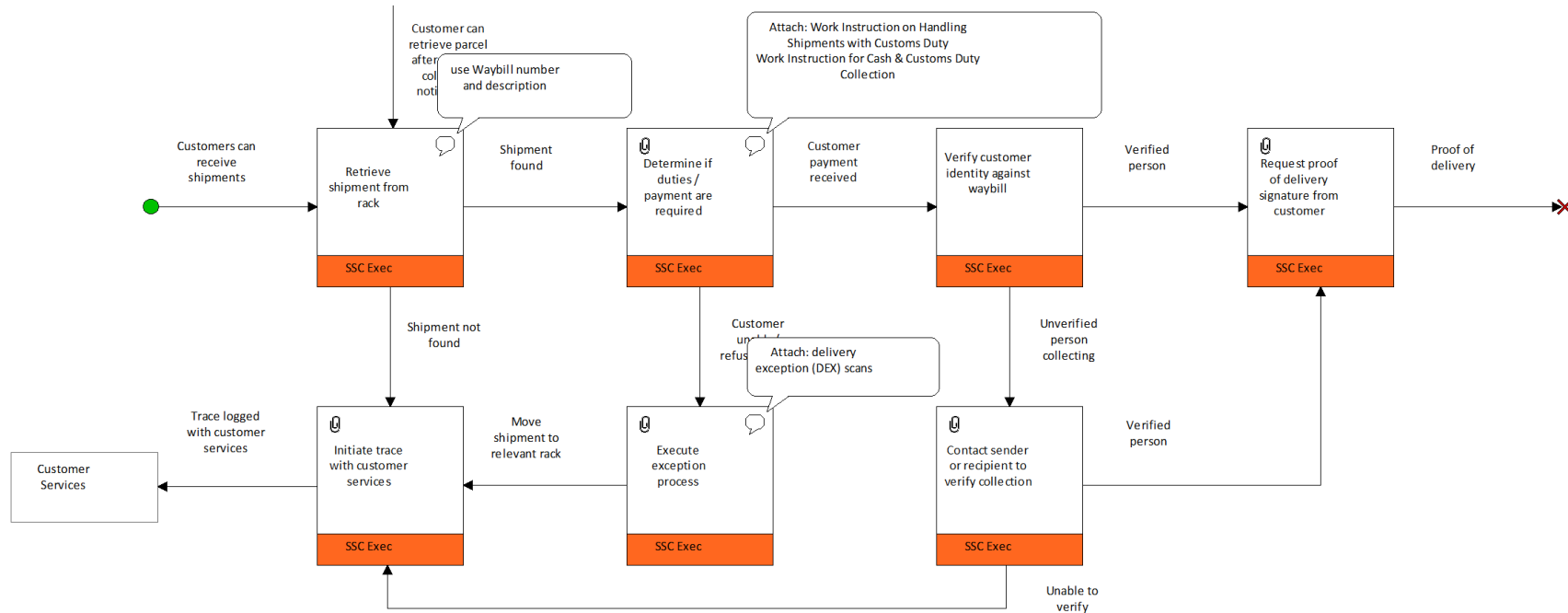



Kuwait - Freight

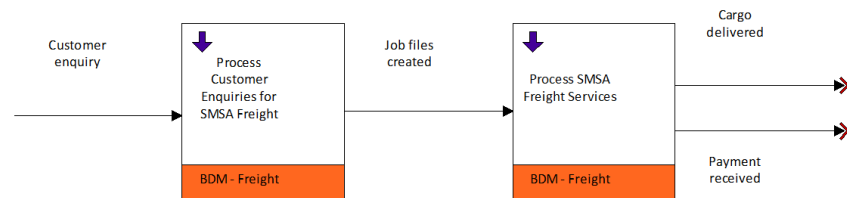

Title: Kuwait - Freight
Author: Edwin Ramos
Date: 4/13/2023
Volume: 0.00 Per Second

Authorization: Update Pending
Cost Per Second: \$,3.5,E-0317

Owner: Shaji George
Diagram Version: Draft Copy
Review Date: None
F.T.E.: 0.00

- Actions
- Change Log
- Change Requests
- Feedback
- Keywords
- Read Only



Process Customer Enquiries for SMSA Freight

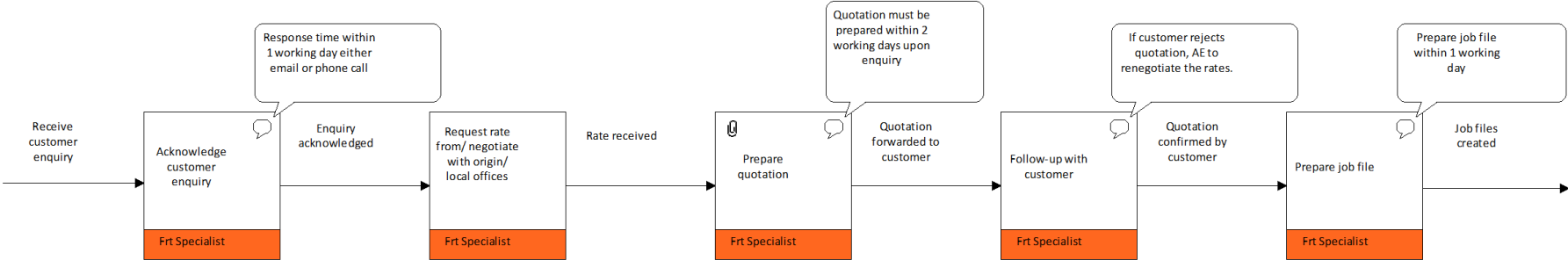

Title: Process Customer Enquiries for SMSA Freight
 Author: Edwin Ramos
 Date: 9/16/2020
 Volume: 0.00 Per Second

Authorization: Update Pending
 Cost Per Second: \$,3.5,E-0317

Owner: Shaji George
 Diagram Version: Draft Copy
 Review Date: None
 F.T.E.: 0.00

- Actions
- Change Log
- Change Requests
- Feedback
- Keywords
- Read Only



Process SMSA Freight Services

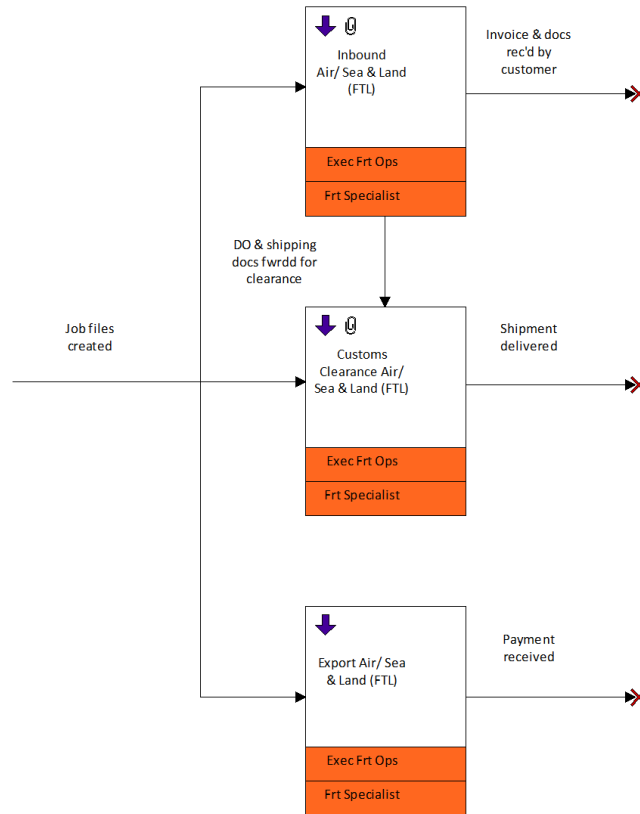

Title: Process SMSA Freight Services
Author: Edwin Ramos
Date: 10/6/2020
Volume: 0.00 Per Second

Authorization: Update Pending
Cost Per Second: \$,3.5,E-0317

Owner: Shaji George
Diagram Version: Draft Copy
Review Date: None
F.T.E.: 0.00

- Actions
- Feedback
- Change Log
- Keywords
- Change Requests
- Read Only

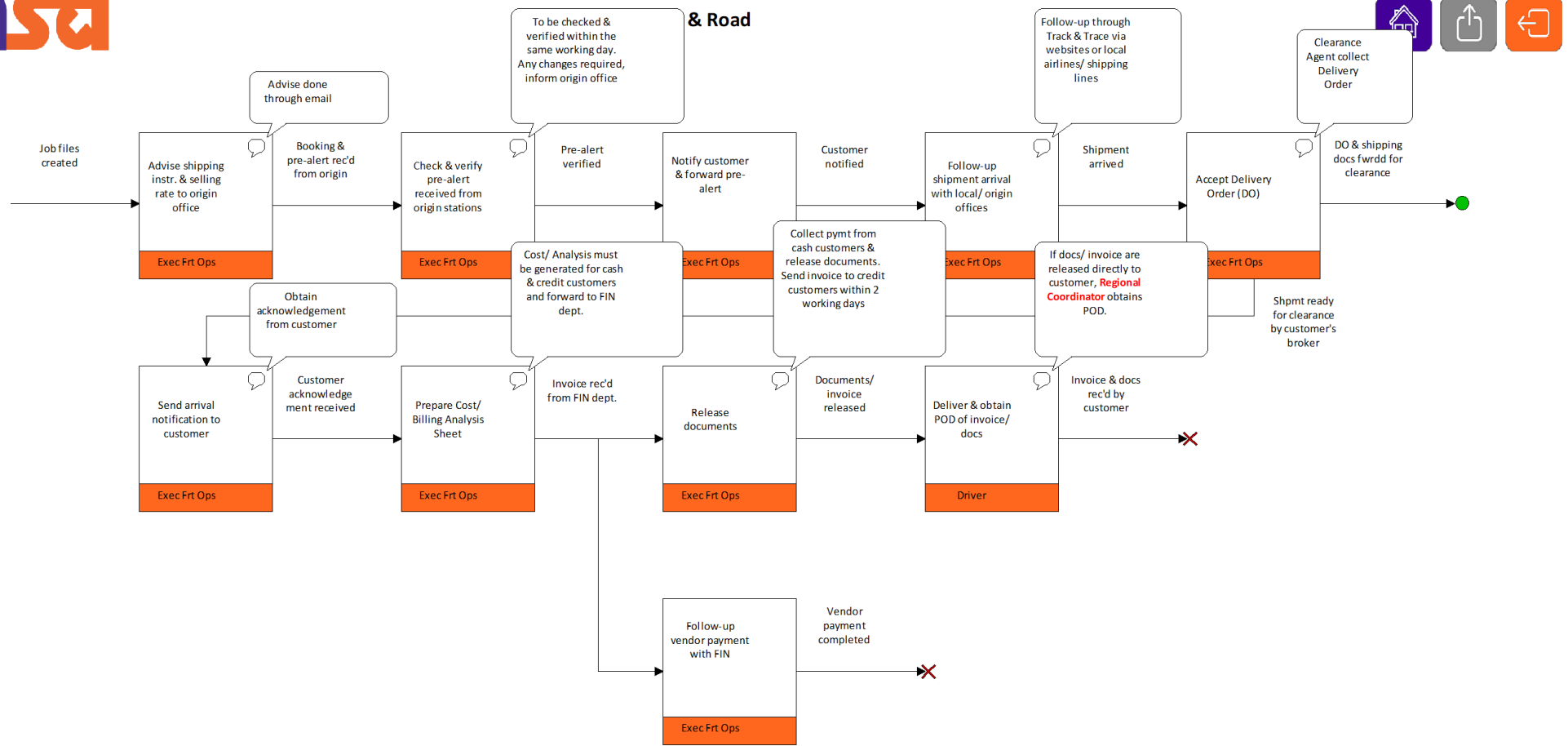

Title: Inbound Air Sea & Road
 Author: Edwin Ramos
 Date: 10/6/2020
 Volume: 0.00 Per Second

Authorization: Update Pending
 Cost Per Second: \$,3.5,E-0317

Owner: Shaji George
 Diagram Version: Draft Copy
 Review Date: None
 F.T.E.: 0.00

- Actions
- Change Log
- Change Requests
- Feedback
- Keywords
- Read Only



Export Air/ Sea & Land (FTL)

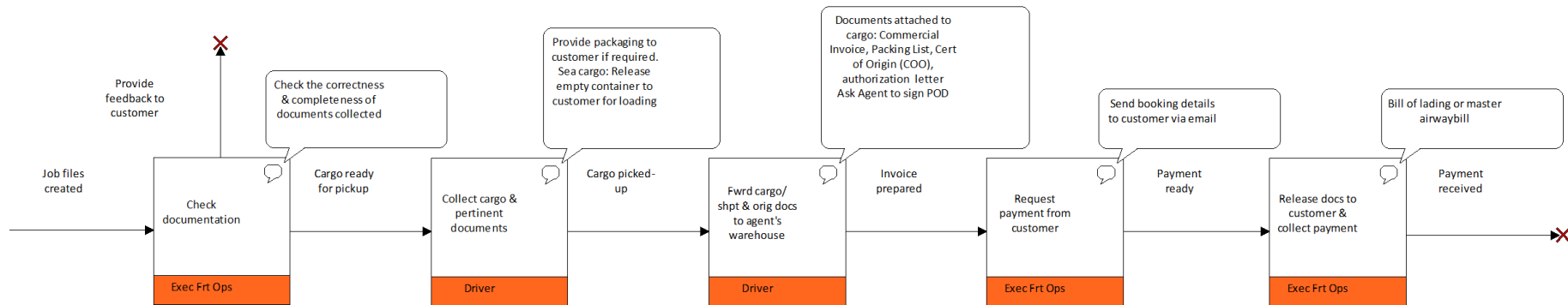

Title: Export Air/ Sea & Land (FTL)
 Author: Edwin Ramos
 Date: 10/6/2020
 Volume: 0.00 Per Second

Authorization: Update Pending
 Cost Per Second: \$,3.5,E-0317

Owner: Shaji George
 Diagram Version: Draft Copy
 Review Date: None
 F.T.E.: 0.00

- Actions
- Change Log
- Change Requests
- Feedback
- Keywords
- Read Only



Customs Clearance Air/ Sea / Road

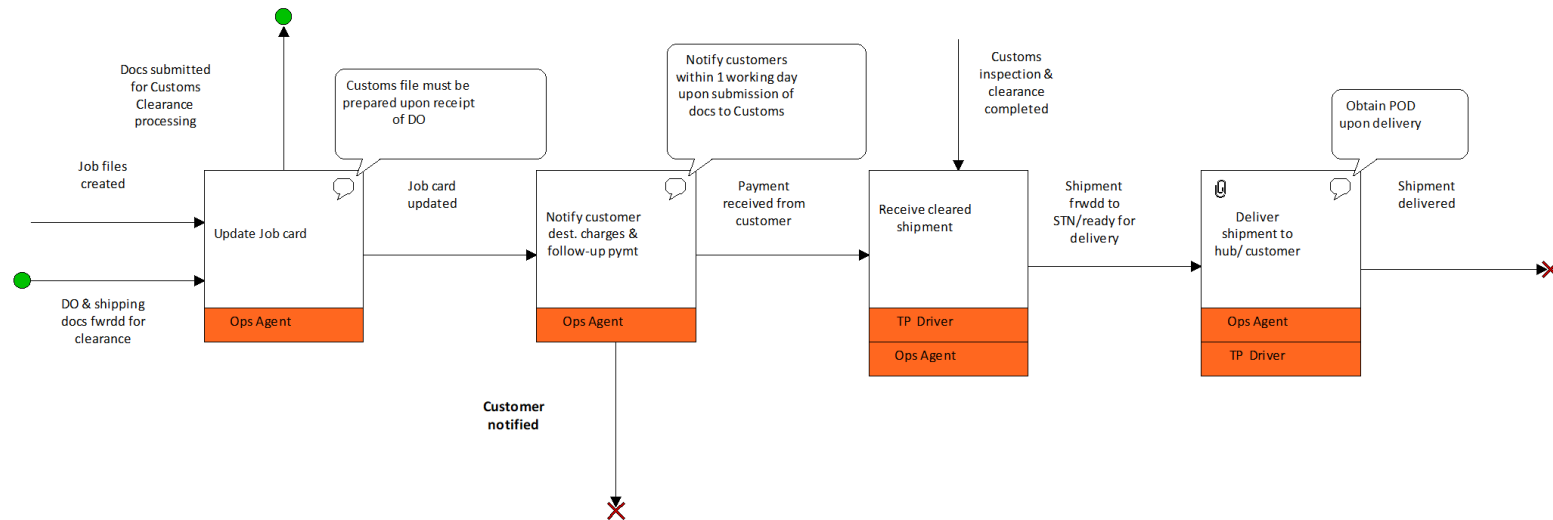



Kuwait - Customer Service

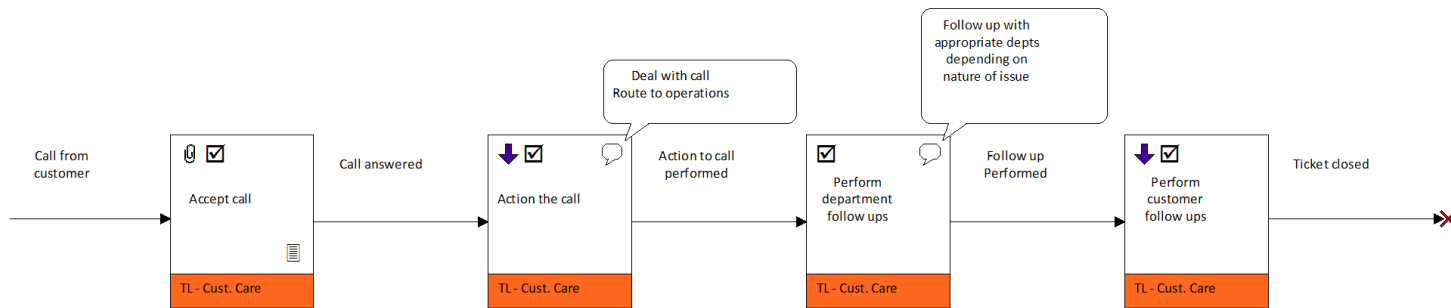

Title: Kuwait - Customer Service
Author: Edwin Ramos
Date: 4/13/2023
Volume: 0.00 Per Second

Authorization: Update Pending
Cost Per Second: \$,3.5,E-0317

Owner: Shaji George
Diagram Version: Draft Copy
Review Date: None
F.T.E.: 0.00

- Actions
- Feedback
- Change Log
- Keywords
- Change Requests
- Read Only



Action the Call

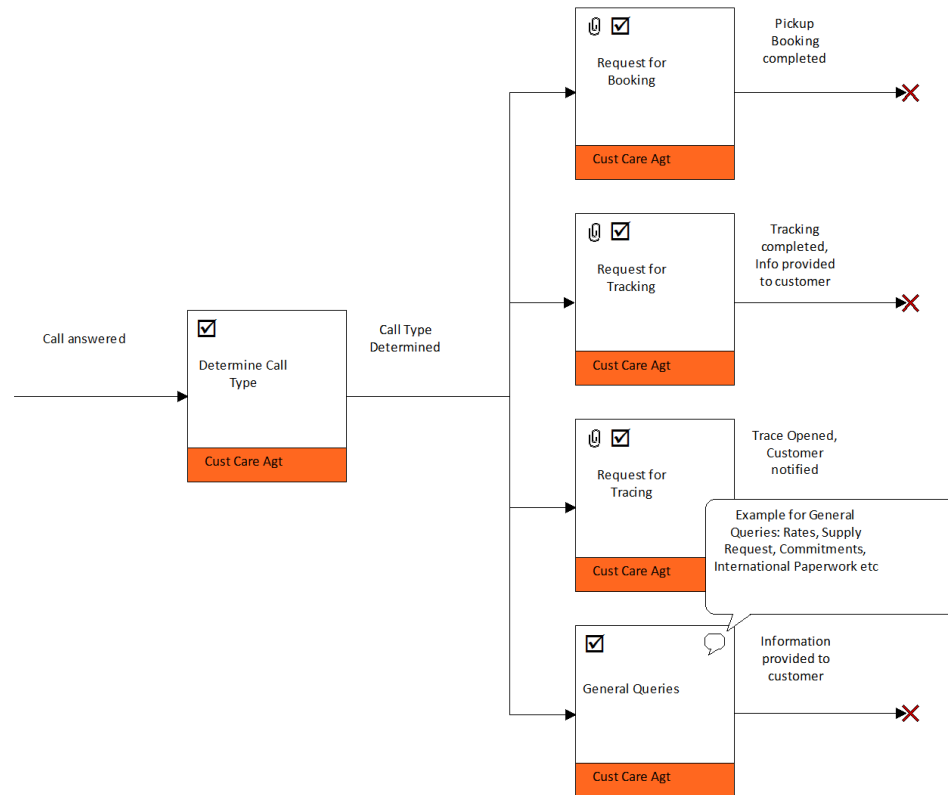

Title: Action the Call
 Author: Edwin Ramos
 Date: 9/11/2020
 Volume: 0.00 Per Second

Authorization: Update Pending
 Cost Per Second: \$,3.5,E-0317

Owner: Shaji George
 Diagram Version: Draft Copy
 Review Date: None
 F.T.E.: 0.00

- Actions
- Change Log
- Change Requests
- Feedback
- Keywords
- Read Only



Perform Customer Follow ups

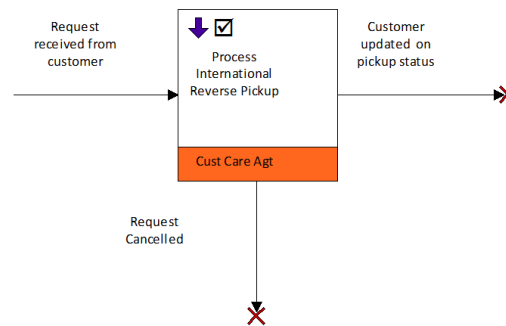

Title: Perform Customer Follow ups
Author: Edwin Ramos
Date: 9/11/2020
Volume: 0.00 Per Second

Authorization: Update Pending
Cost Per Second: \$,3.5,E-0317

Owner: Shaji George
Diagram Version: Draft Copy
Review Date: None
F.T.E.: 0.00

- Actions
- Change Log
- Change Requests
- Feedback
- Keywords
- Read Only



Process International Reverse Pickup

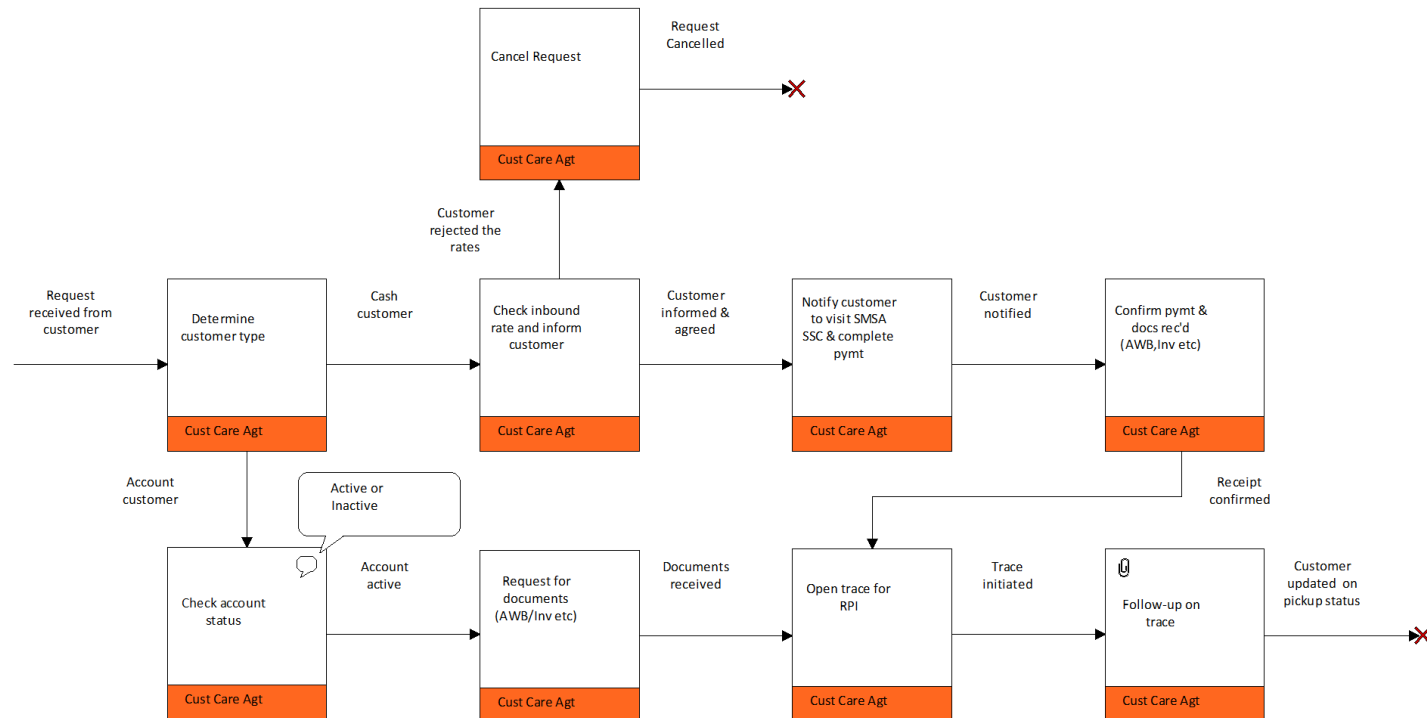

Title: Process International Reverse Pickup
 Author: Edwin Ramos
 Date: 9/11/2020
 Volume: 0.00 Per Second
 Authorization: Update Pending
 Cost Per Second: \$,3.5,E-0317

Owner: Shaji George
 Diagram Version: Draft Copy
 Review Date: None
 F.T.E.: 0.00

- Actions
- Change Log
- Change Requests
- Feedback
- Keywords
- Read Only

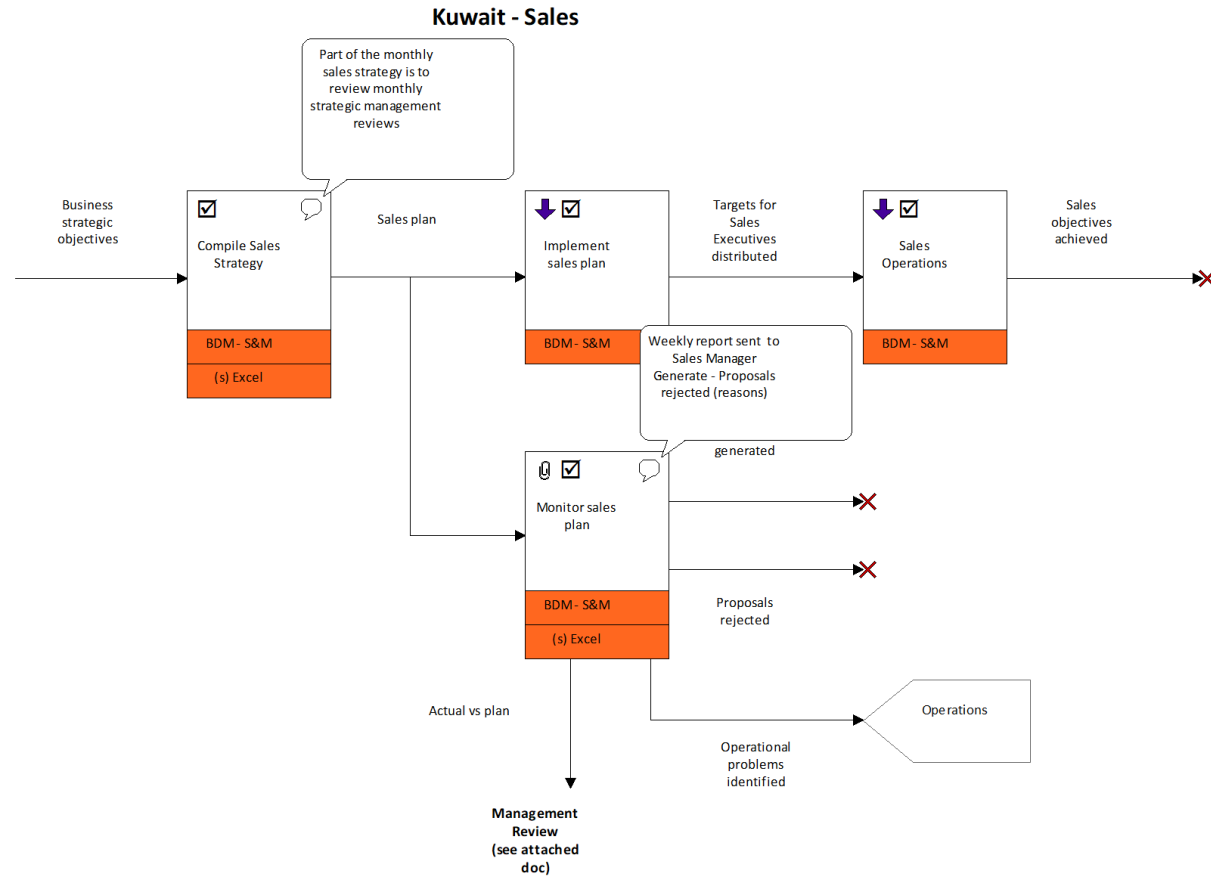



Sales Operations

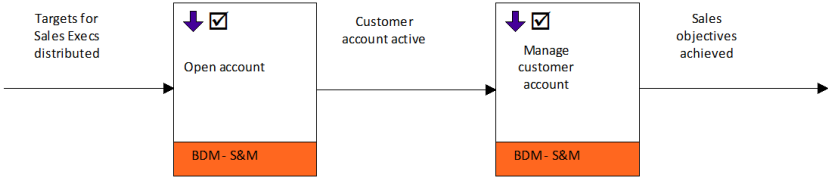

Title: Sales Operations
 Author: Edwin Ramos
 Date: 10/1/2024
 Volume: 0.00 Per Second

Authorization: Update Pending
 Cost Per Second: \$,3.5,E-0317

Owner: Edwin Ramos
 Diagram Version: Draft Copy
 Review Date: None
 F.T.E.: 0.00

- Actions
- Change Log
- Change Requests
- Feedback
- Keywords
- Read Only



Account Opening Process

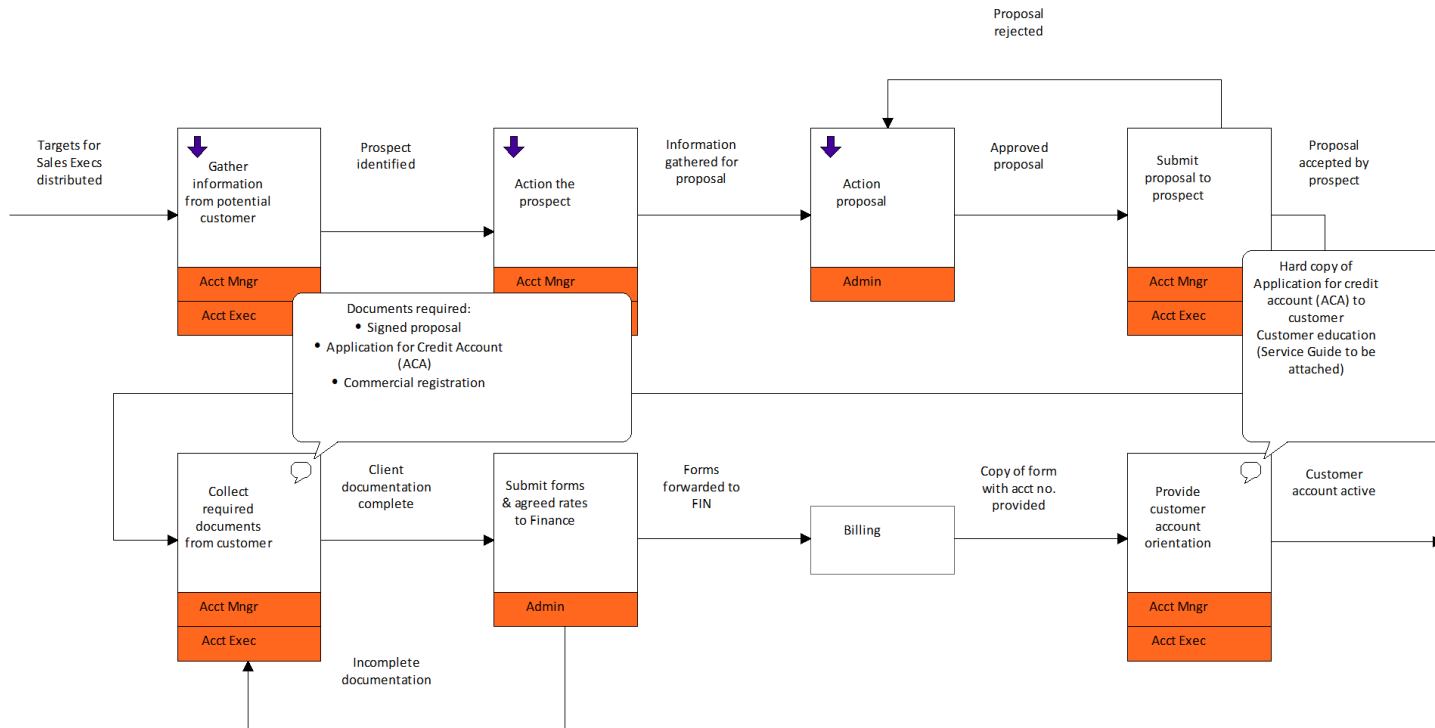

Title: Account Opening Process
 Author: Edwin Ramos
 Date: 5/22/2010
 Volume: 0.00 Per Second

Authorization: Update Pending
 Cost Per Second: \$,3.5,E-0317

Owner: Shaji George
 Diagram Version: Draft Copy
 Review Date: None
 F.T.E.: 0.00

- Actions
- Change Log
- Change Requests
- Feedback
- Keywords
- Read Only



Gather Information from Potential Customer

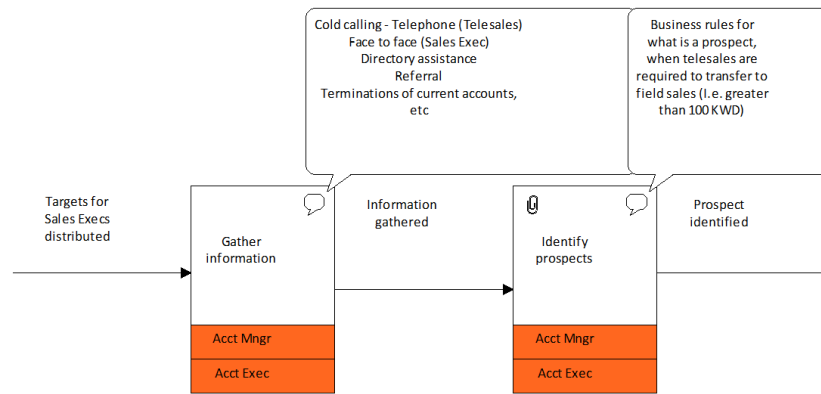

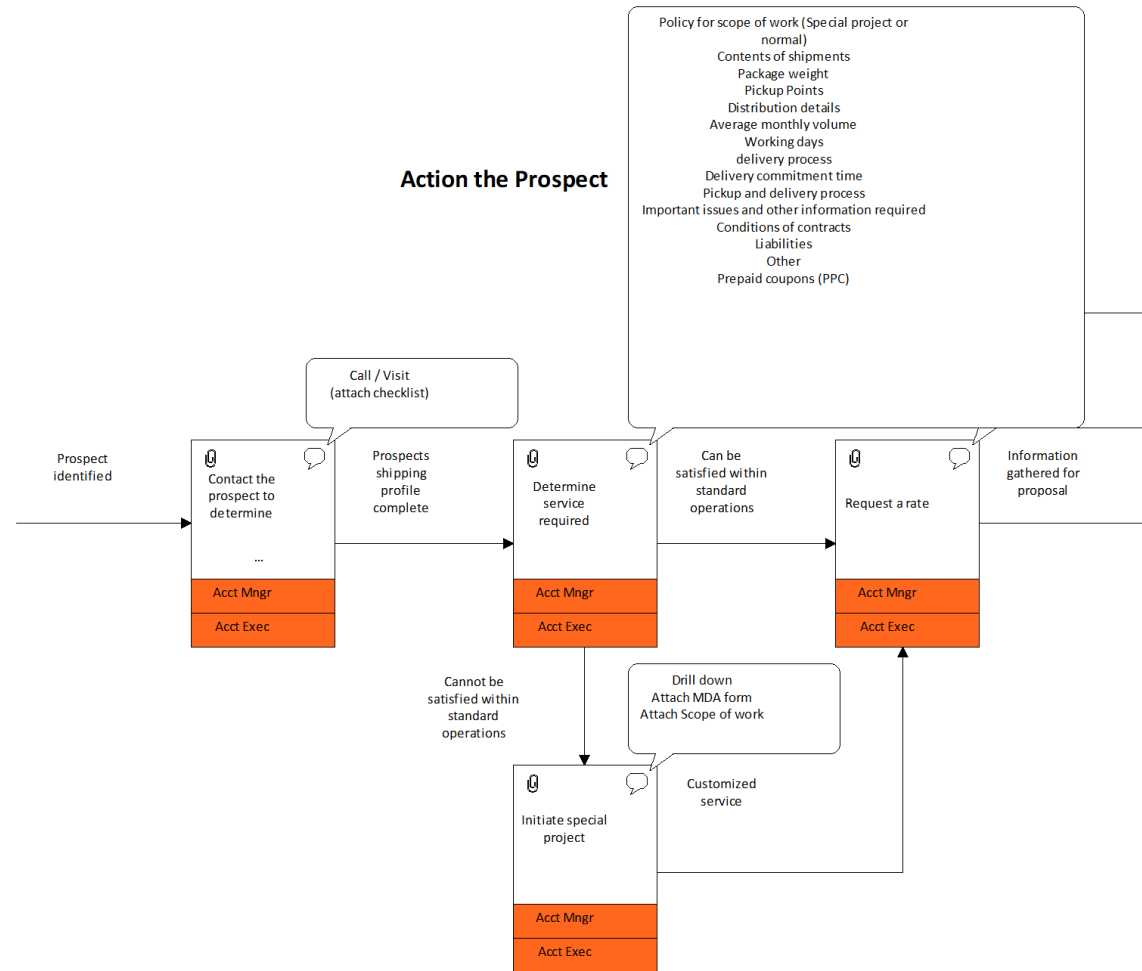

Title: Action the Prospect
 Author: Edwin Ramos
 Date: 5/22/2010
 Volume: 0.00 Per Second

Authorization: Update Pending
 Cost Per Second: \$,3.5,E-0317

Owner: Shaji George
 Diagram Version: Draft Copy
 Review Date: None
 F.T.E.: 0.00

- Actions
- Change Log
- Change Requests
- Feedback
- Keywords
- Read Only



Action Proposal

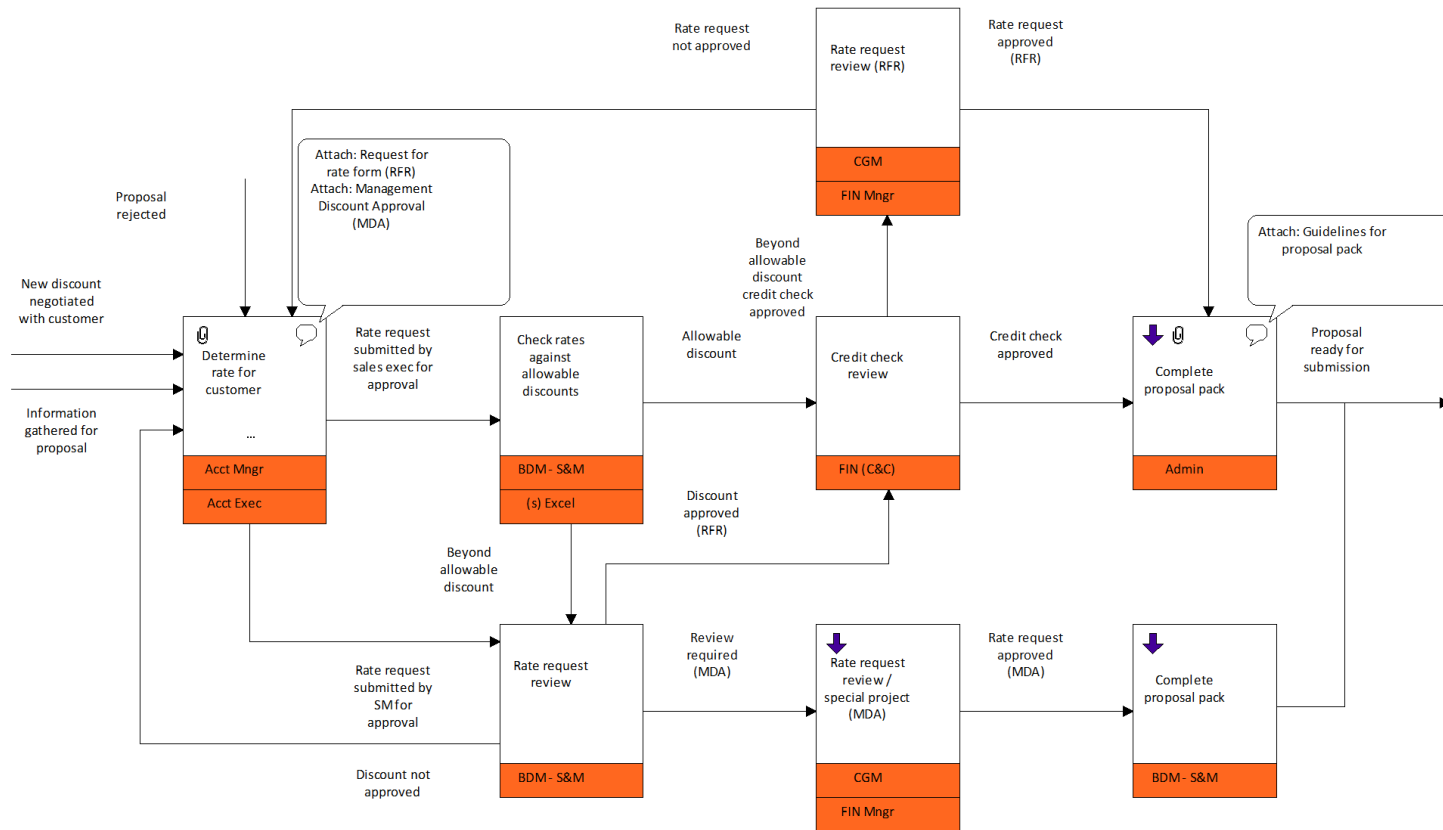

Title: Action Proposal
 Author: Edwin Ramos
 Date: 5/22/2010
 Volume: 0.00 Per Second

Authorization: Update Pending
 Cost Per Second: \$,3.5,E-0317

Owner: Shaji George
 Diagram Version: Draft Copy
 Review Date: None
 F.T.E.: 0.00

- Actions
- Change Log
- Change Requests
- Feedback
- Keywords
- Read Only



Complete Proposal Pack

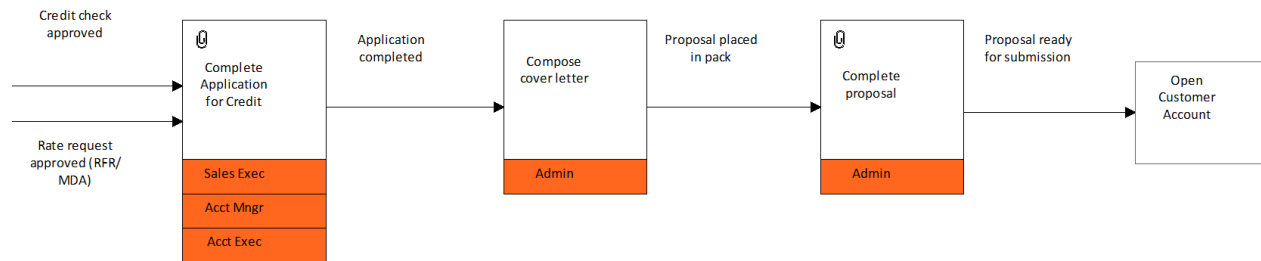

Title: Complete Proposal Pack
 Author: Edwin Ramos
 Date: 5/22/2010
 Volume: 0.00 Per Second

Authorization: Update Pending
 Cost Per Second: \$,3.5,E-0317

Owner: Shaji George
 Diagram Version: Draft Copy
 Review Date: None
 F.T.E.: 0.00

- Actions
- Change Log
- Change Requests
- Feedback
- Keywords
- Read Only



Rate Request Review / Special Project (MDA)

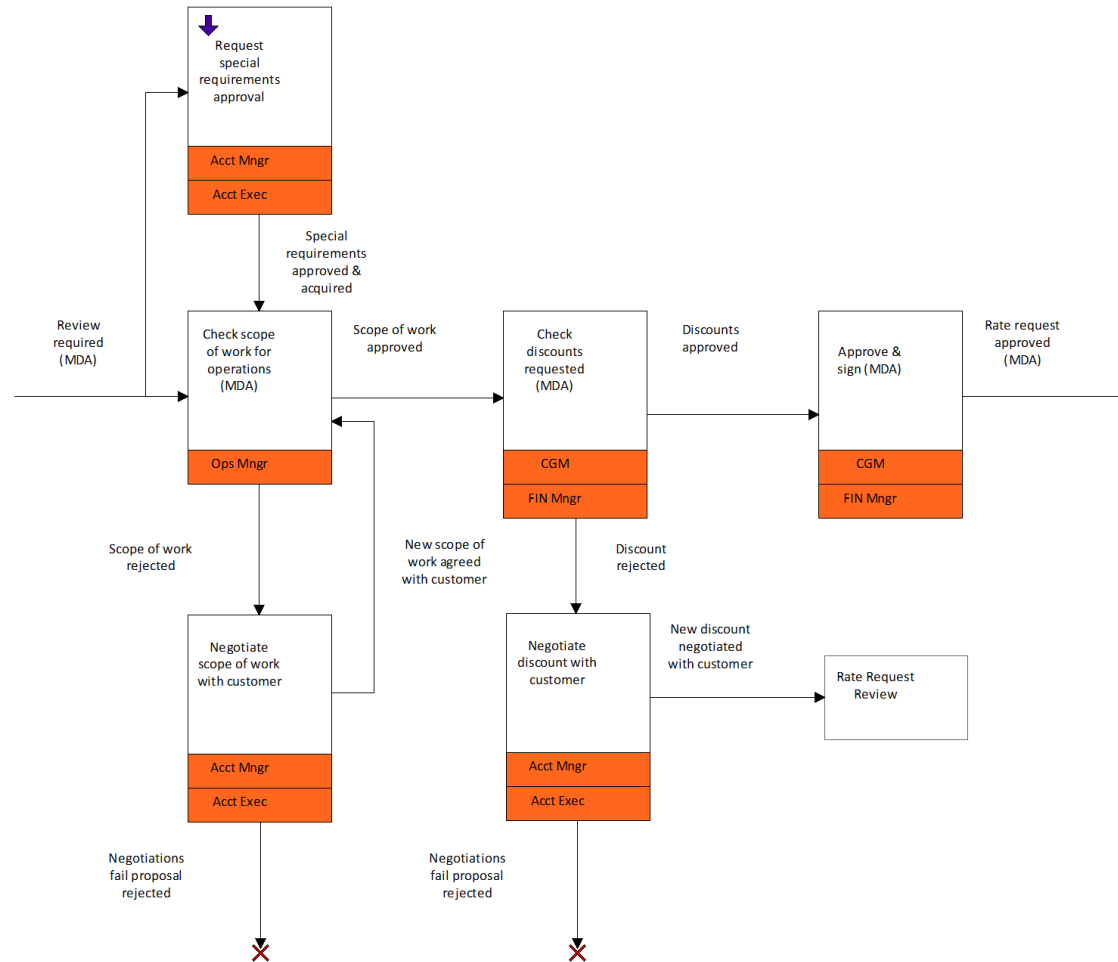



Request Special Requirements Approval

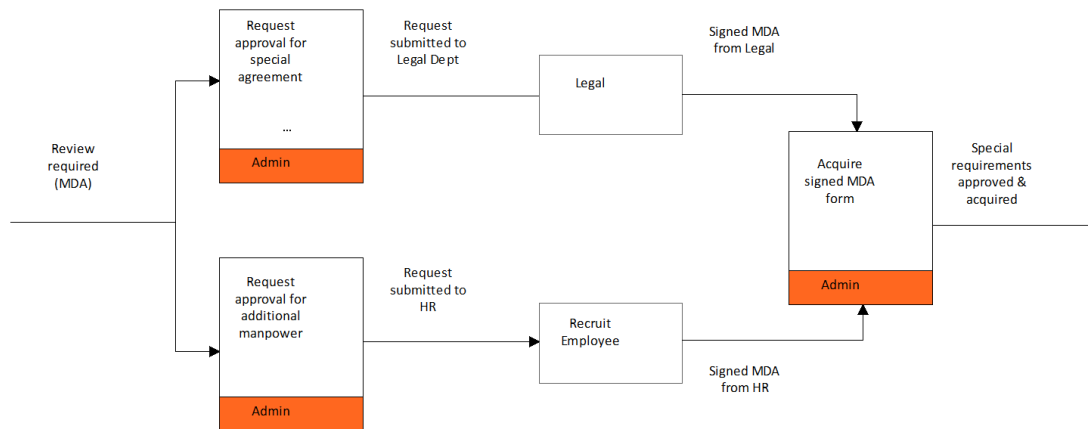

Title: Request Special Requirements Approval
 Author: Edwin Ramos
 Date: 5/29/2010
 Volume: 0.00 Per Second
 Authorization: Update Pending
 Cost Per Second: \$,3.5,E-0317

Owner: Shaji George
 Diagram Version: Draft Copy
 Review Date: None
 F.T.E.: 0.00

- Actions
- Feedback
- Change Log
- Keywords
- Change Requests
- Read Only



Complete Proposal Pack

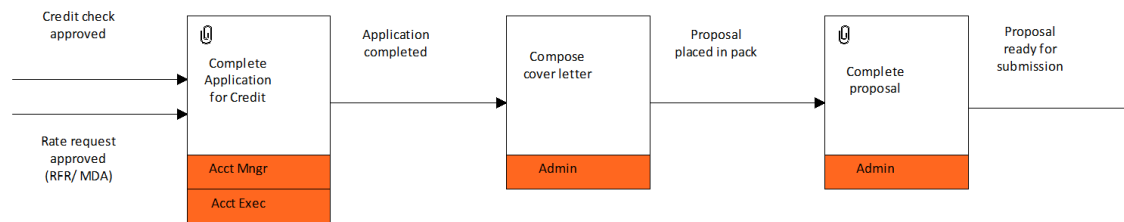

Title: Complete Proposal Pack
 Author: Edwin Ramos
 Date: 5/29/2010
 Volume: 0.00 Per Second

Authorization: Update Pending
 Cost Per Second: \$,3.5,E-0317

Owner: Shaji George
 Diagram Version: Draft Copy
 Review Date: None
 F.T.E.: 0.00

- Actions
- Feedback
- Change Log
- Keywords
- Change Requests
- Read Only



Manage Customer Account

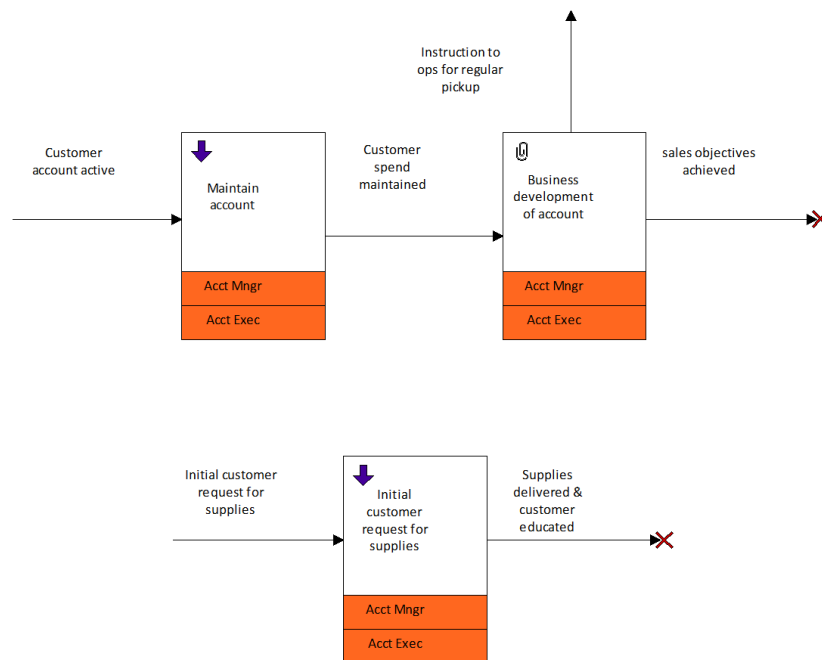

Title: Manage Customer Account
 Author: Edwin Ramos
 Date: 10/1/2024
 Volume: 0.00 Per Second

Authorization: Update Pending
 Cost Per Second: \$,3.5,E-0317

Owner: Edwin Ramos
 Diagram Version: Draft Copy
 Review Date: None
 F.T.E.: 0.00

- Actions
- Feedback
- Change Log
- Keywords
- Change Requests
- Read Only



Maintain Account

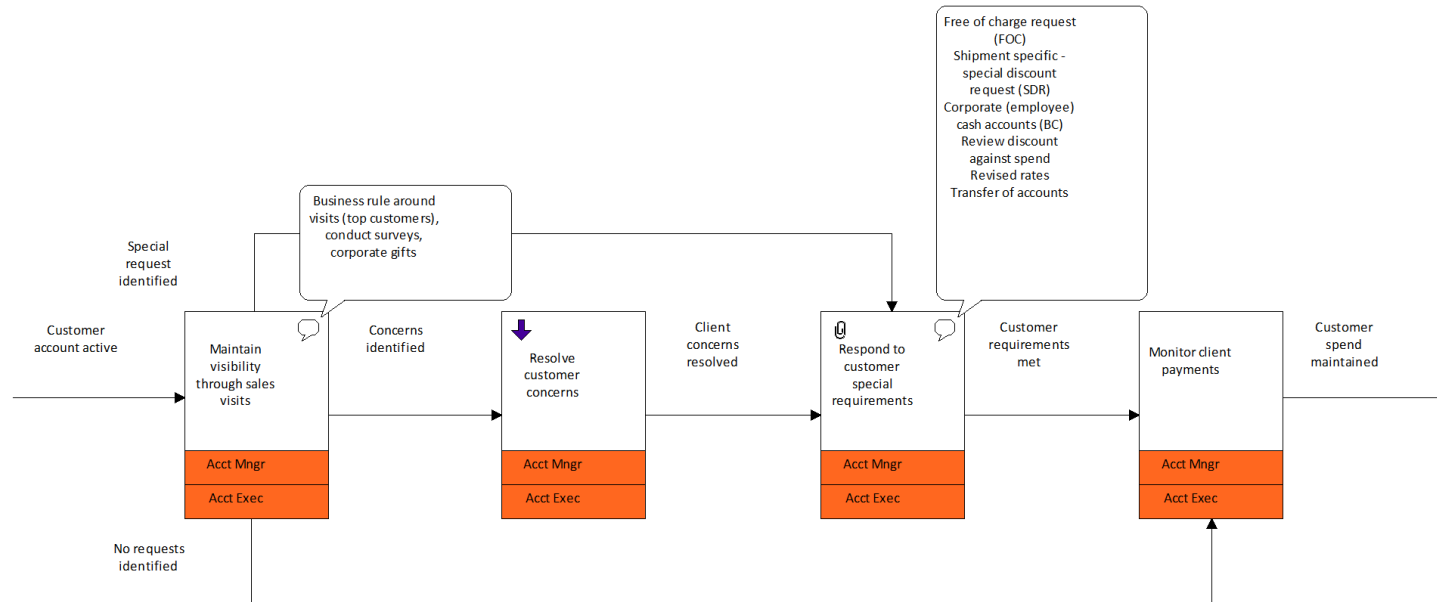

Title: Maintain Account
 Author: Edwin Ramos
 Date: 5/22/2010
 Volume: 0.00 Per Second

Authorization: Update Pending
 Cost Per Second: \$,3.5,E-0317

Owner: Shaji George
 Diagram Version: Draft Copy
 Review Date: None
 F.T.E.: 0.00

- Actions
- Change Log
- Change Requests
- Feedback
- Keywords
- Read Only



Resolve Customer Concerns

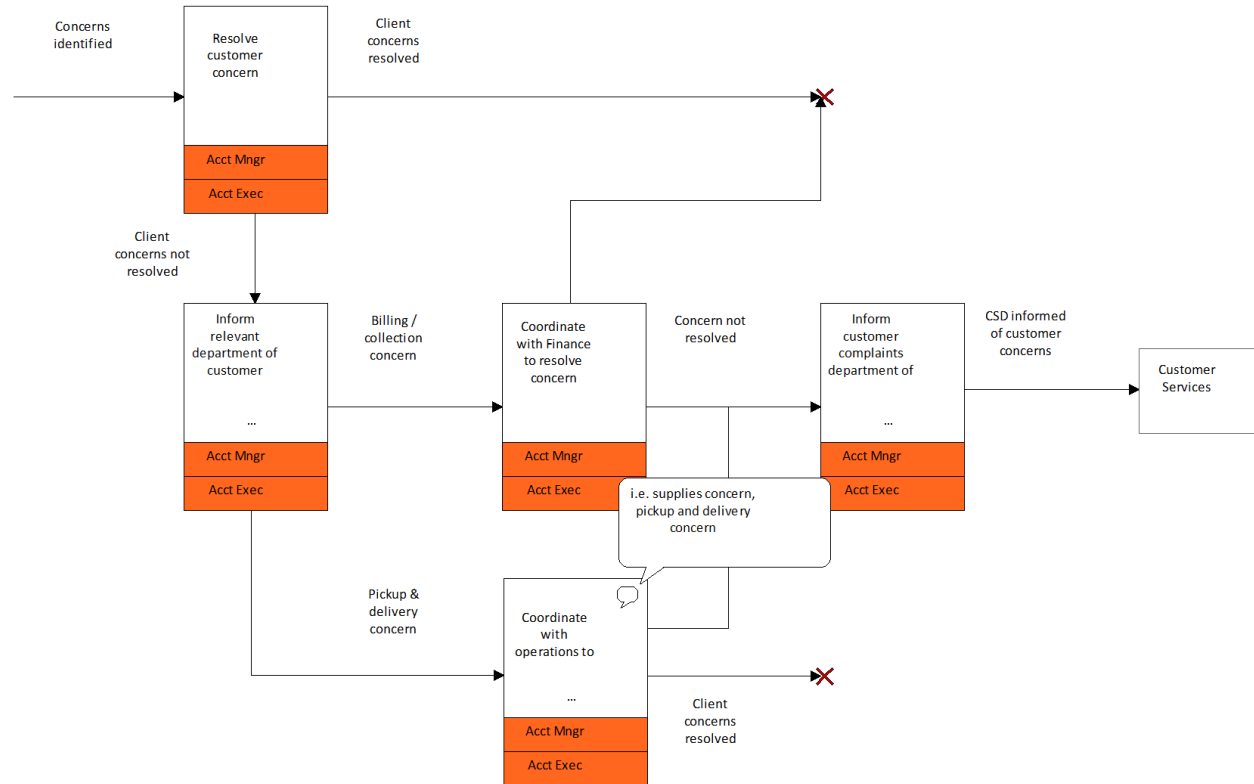

Title: Resolve Customer Concerns
 Author: Edwin Ramos
 Date: 5/29/2010
 Volume: 0.00 Per Second

Authorization: Update Pending
 Cost Per Second: \$,3.5,E-0317

Owner: Shaji George
 Diagram Version: Draft Copy
 Review Date: None
 F.T.E.: 0.00

- Actions
- Change Log
- Change Requests
- Feedback
- Keywords
- Read Only



Initial Customer Request for Supplies

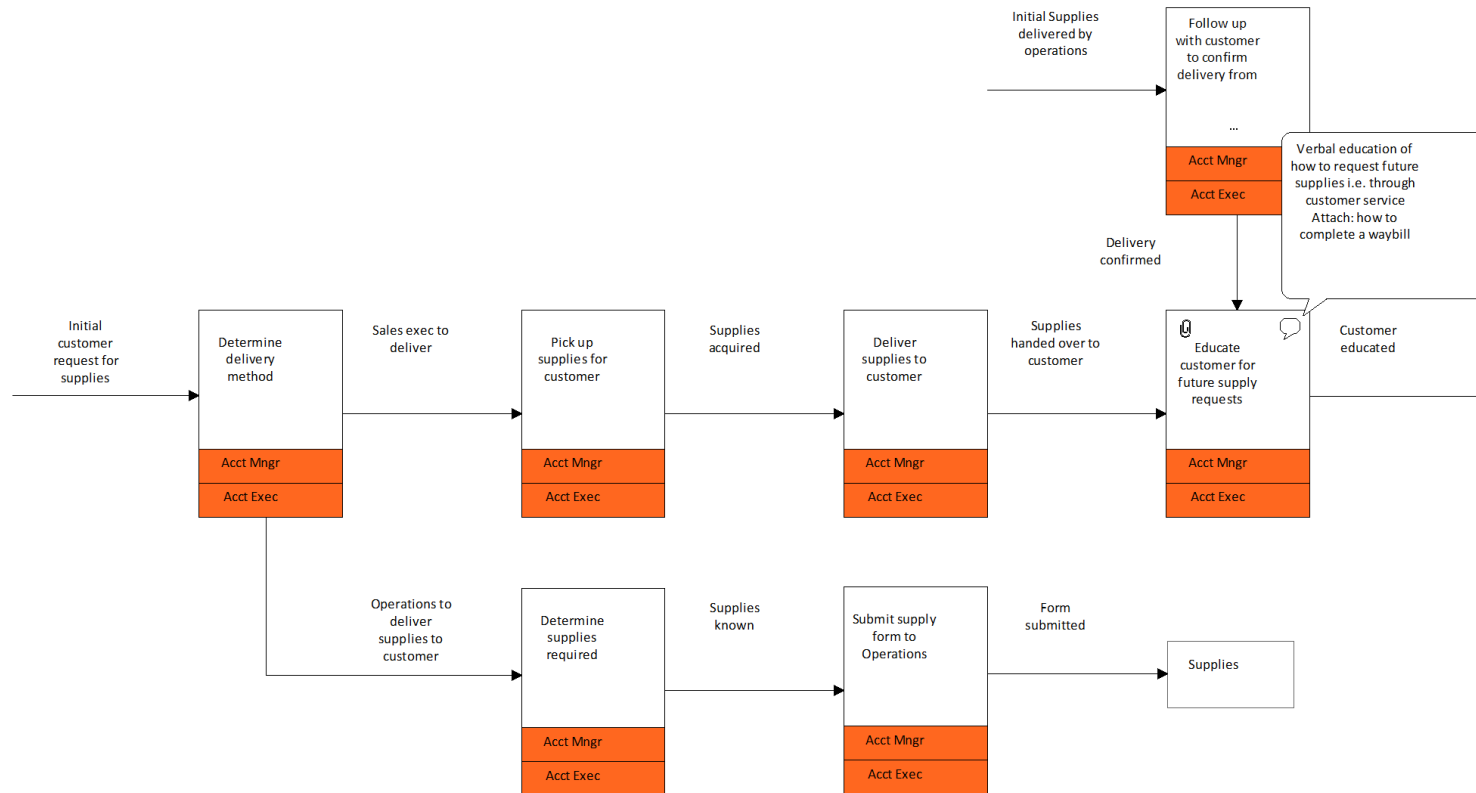

Title: Initial Customer Request for Supplies
 Author: Edwin Ramos
 Date: 5/29/2010
 Volume: 0.00 Per Second
 Authorization: Update Pending
 Cost Per Second: \$,3.5,E-0317

Owner: Shaji George
 Diagram Version: Draft Copy
 Review Date: None
 F.T.E.: 0.00

- Actions
- Change Log
- Change Requests
- Feedback
- Keywords
- Read Only



Implement Sales Plan

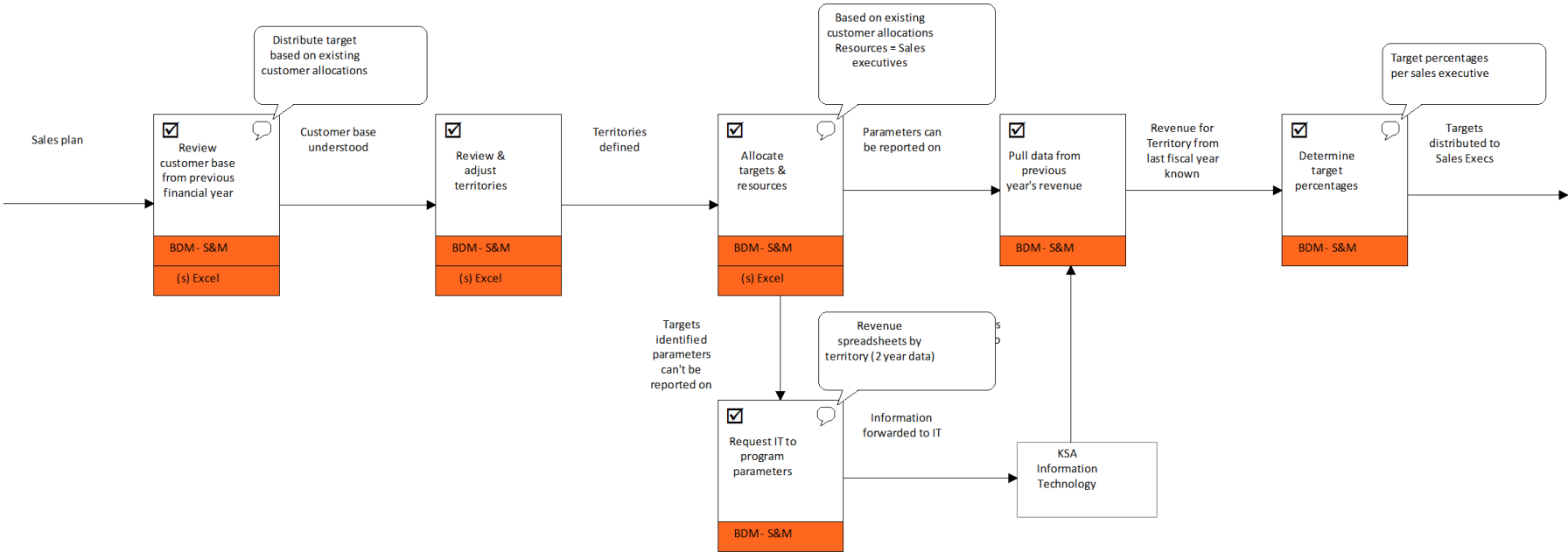

Title: Implement Sales Plan
 Author: Edwin Ramos
 Date: 6/7/2018
 Volume: 0.00 Per Second

Authorization: Update Pending
 Cost Per Second: \$,3.5,E-0317

Owner: Shaji George
 Diagram Version: Draft Copy
 Review Date: None
 F.T.E.: 0.00

- Actions
- Change Log
- Change Requests
- Feedback
- Keywords
- Read Only



Kuwait - Human Resources & Admin

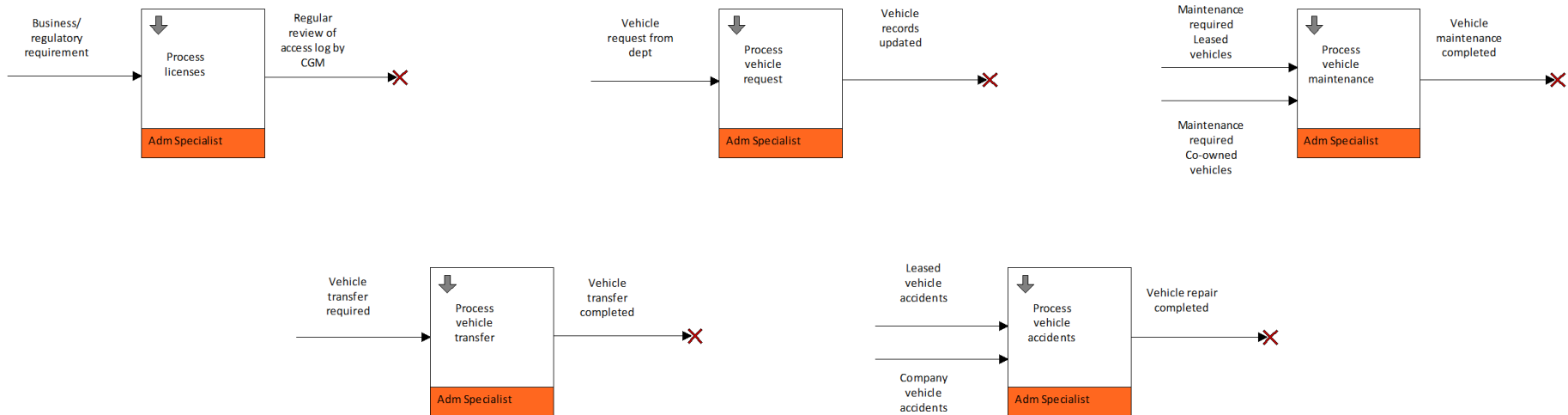



Process Vehicle Request

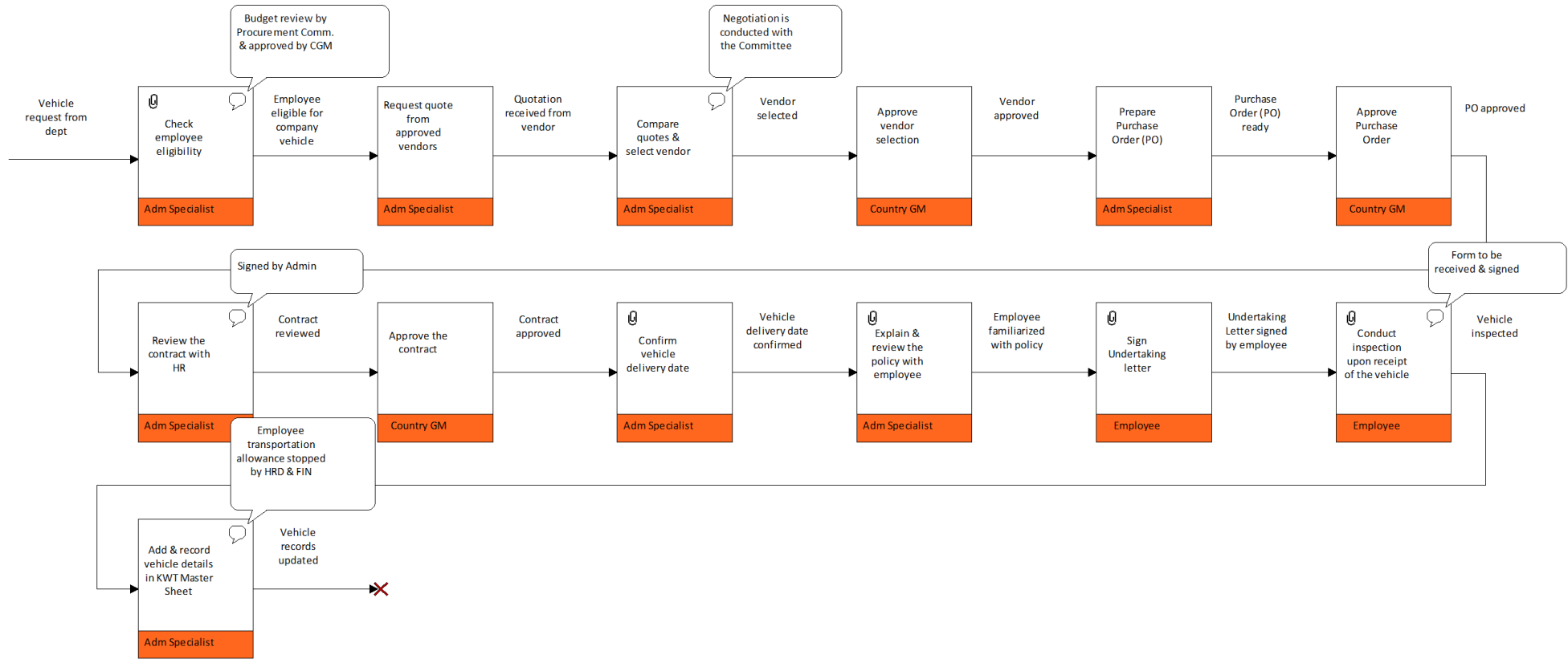

Title: Process Vehicle Request
 Author: Edwin Ramos
 Date: 8/25/2024
 Volume: 0.00 Per Second

Authorization: Authorization Pending
 By: 1/29/2025
 Cost Per Second: \$,3.5,E-0317

Owner: Edwin Ramos
 Diagram Version: Draft Copy
 Review Date: None
 F.T.E.: 0.00

- Actions
- Change Log
- Change Requests
- Feedback
- Keywords
- Read Only



Process Vehicle Transfer

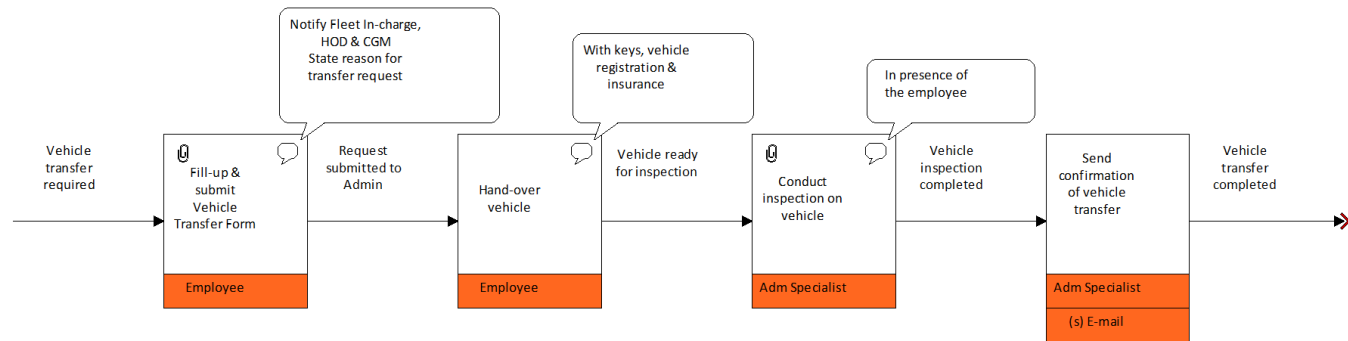

Title: Process Vehicle Transfer
Author: Edwin Ramos
Date: 8/25/2024
Volume: 0.00 Per Second

Authorization: Update Pending
Cost Per Second: \$,3.5,E-0317

Owner: Edwin Ramos
Diagram Version: Draft Copy
Review Date: None
F.T.E.: 0.00

- Actions
- Change Log
- Change Requests
- Feedback
- Keywords
- Read Only



Process Vehicle Maintenance

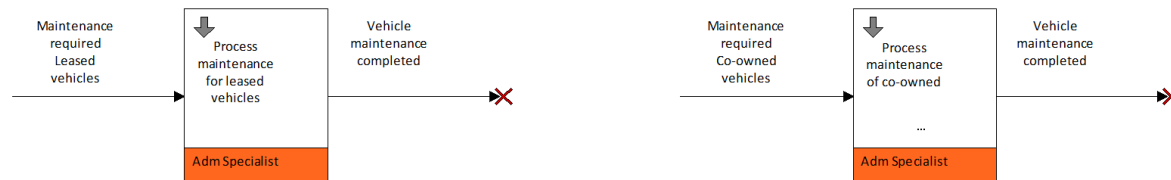

Title: Process Vehicle Maintenance
Author: Edwin Ramos
Date: 8/25/2024
Volume: 0.00 Per Second
Authorization: Update Pending
Cost Per Second: \$,3.5,E-0317

Owner: Edwin Ramos
Diagram Version: Draft Copy
Review Date: None
F.T.E.: 0.00

- Actions
- Change Log
- Change Requests
- Feedback
- Keywords
- Read Only



Process Maintenance for Leased Vehicles

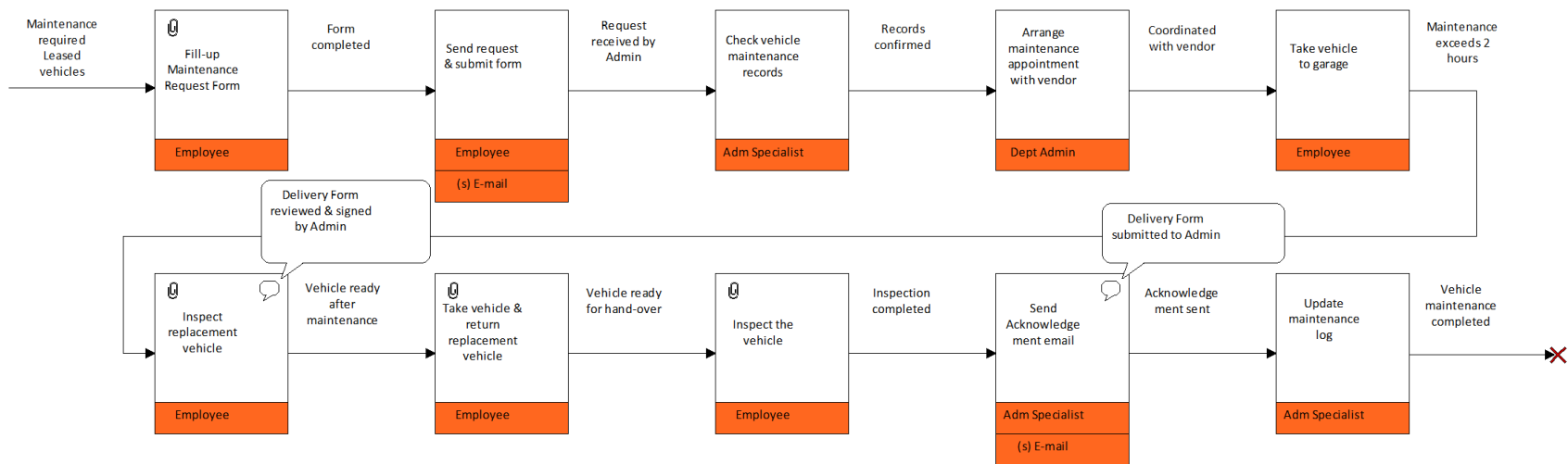

Title: Process Maintenance for Leased Vehicles
 Author: Edwin Ramos
 Date: 9/2/2024
 Volume: 0.00 Per Second
 Authorization: Update Pending
 Cost Per Second: \$,3.5,E-0317

Owner: Edwin Ramos
 Diagram Version: Draft Copy
 Review Date: None
 F.T.E.: 0.00

- Actions
- Change Log
- Change Requests
- Feedback
- Keywords
- Read Only



Process Maintenance for Co-owned Vehicles

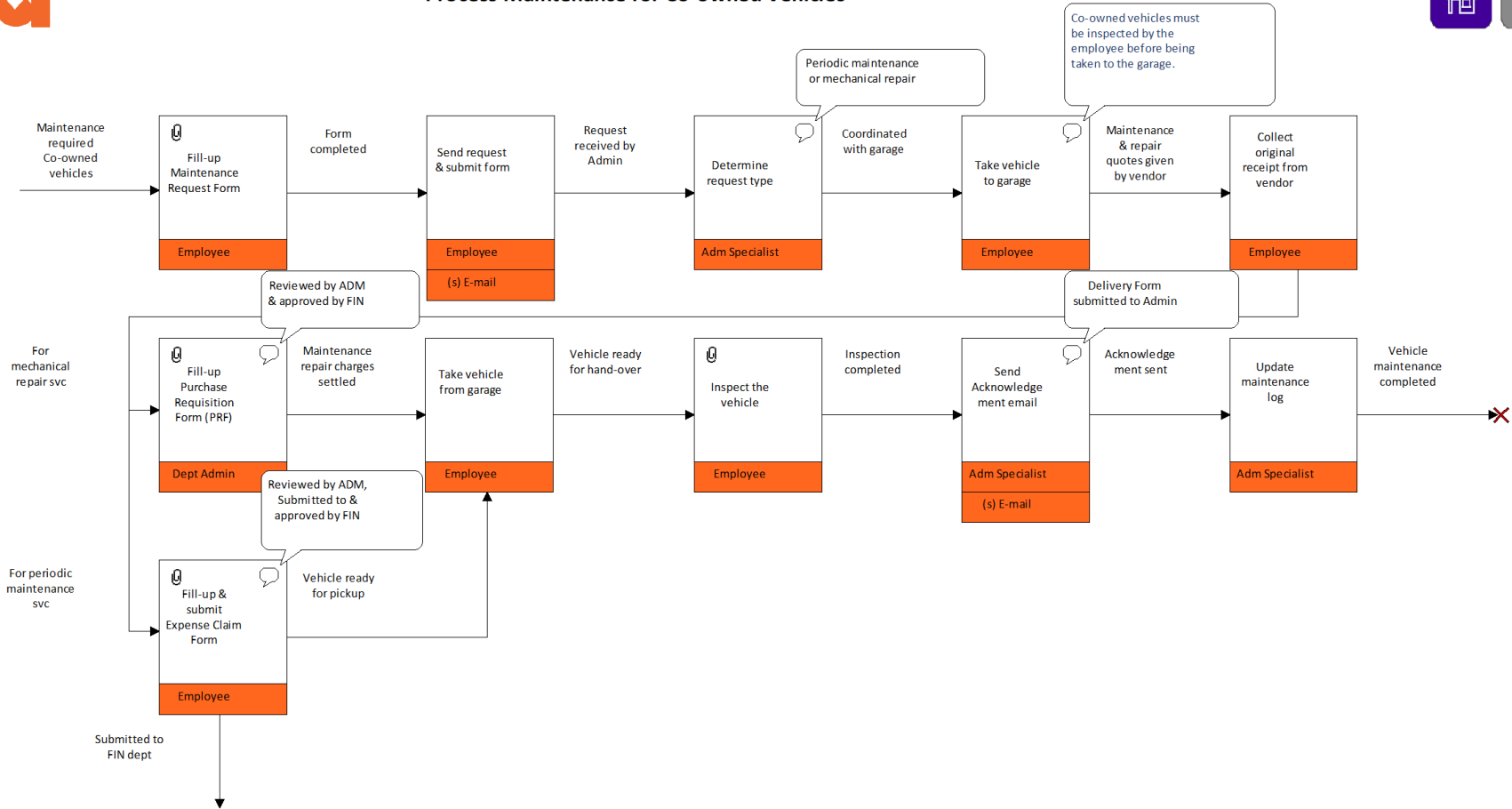



Process Vehicle Accidents



Title: Process Vehicle Accidents
Author: Edwin Ramos
Date: 8/25/2024
Volume: 0.00 Per Second

Authorization: Update Pending
Cost Per Second: \$,3.5,E-0317

Owner: Edwin Ramos
Diagram Version: Draft Copy
Review Date: None
F.T.E.: 0.00

- Actions
- Change Log
- Change Requests
- Feedback
- Keywords
- Read Only



Process Accidents for Leased Vehicles

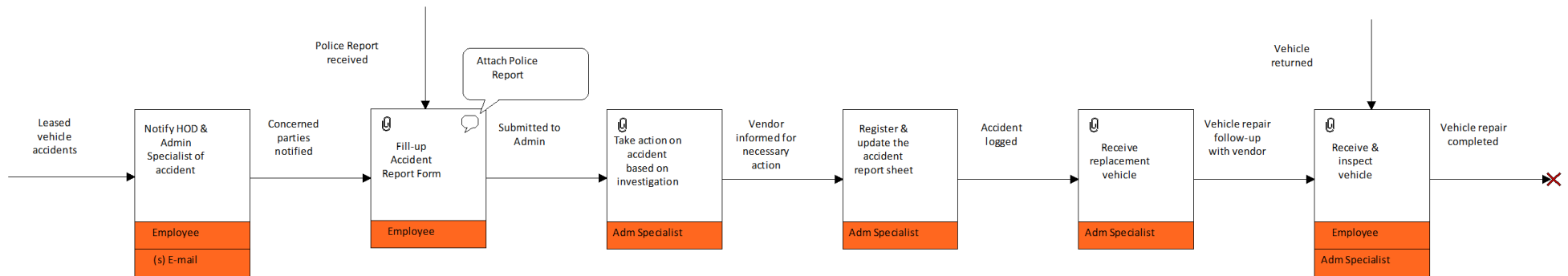

Title: Process Accidents for Leased Vehicles
 Author: Edwin Ramos
 Date: 9/8/2024
 Volume: 0.00 Per Second
 Authorization: Update Pending
 Cost Per Second: \$,3.5,E-0317

Owner: Edwin Ramos
 Diagram Version: Draft Copy
 Review Date: None
 F.T.E.: 0.00

- Actions
- Change Log
- Change Requests
- Feedback
- Keywords
- Read Only



Process Accidents for Company Vehicles

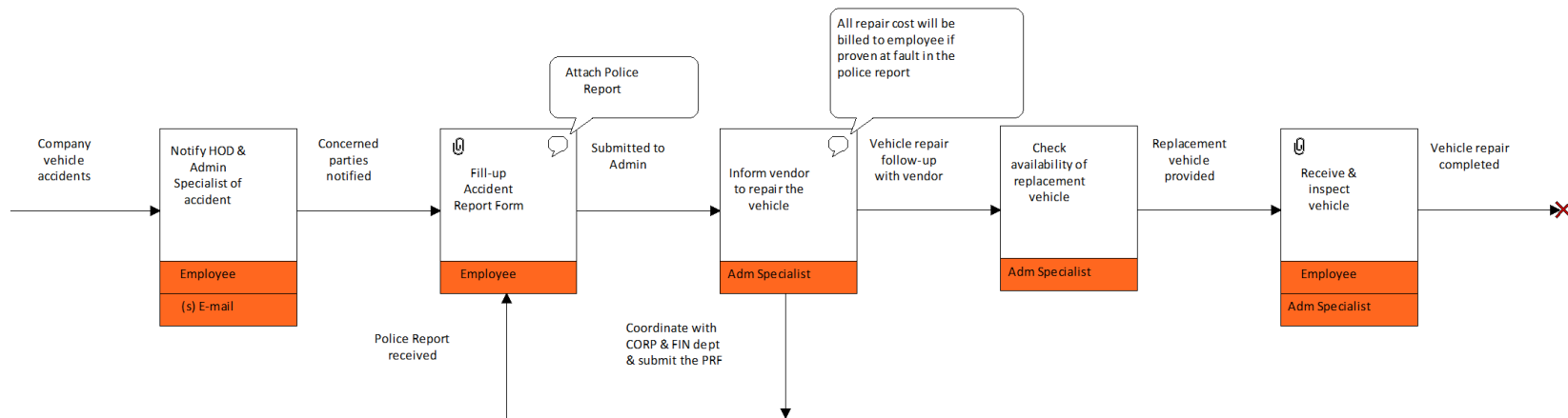

Title: Process Accidents for Company Vehicles
 Author: Edwin Ramos
 Date: 9/8/2024
 Volume: 0.00 Per Second
 Authorization: Update Pending
 Cost Per Second: \$,3.5,E-0317

Owner: Edwin Ramos
 Diagram Version: Draft Copy
 Review Date: None
 F.T.E.: 0.00

- Actions
- Change Log
- Change Requests
- Feedback
- Keywords
- Read Only



Process Licenses

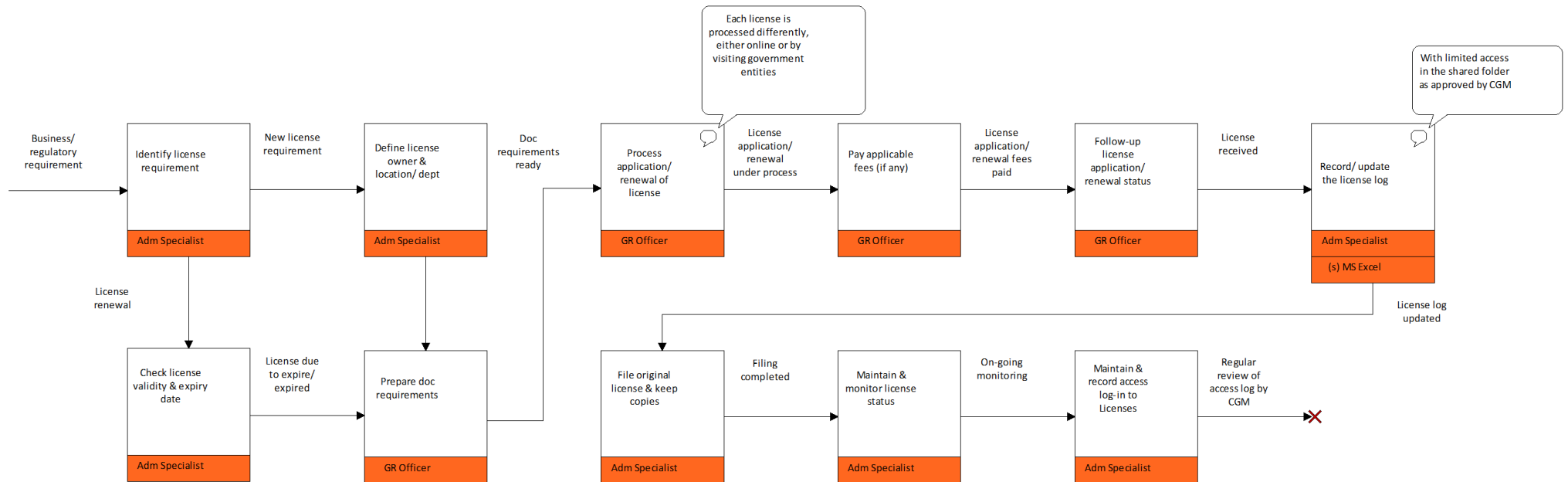

Title: Process Licenses
 Author: Edwin Ramos
 Date: 8/25/2024
 Volume: 0.00 Per Second

Authorization: Update Pending
 Cost Per Second: \$,3.5,E-0317

Owner: Edwin Ramos
 Diagram Version: Draft Copy
 Review Date: None
 F.T.E.: 0.00

- Actions
- Change Log
- Change Requests
- Feedback
- Keywords
- Read Only



Kuwait - Finance



Billing



Collections



Payroll



Purchasing

Title: Kuwait - Finance
Author: Edwin Ramos
Date: 4/13/2023
Volume: 0.00 Per Second

Authorization: Update Pending
Cost Per Second: \$,3.5,E-0317

Owner: Shaji George
Diagram Version: Draft Copy
Review Date: None
F.T.E.: 0.00

- Actions
- Change Log
- Change Requests
- Feedback
- Keywords
- Read Only



Billing

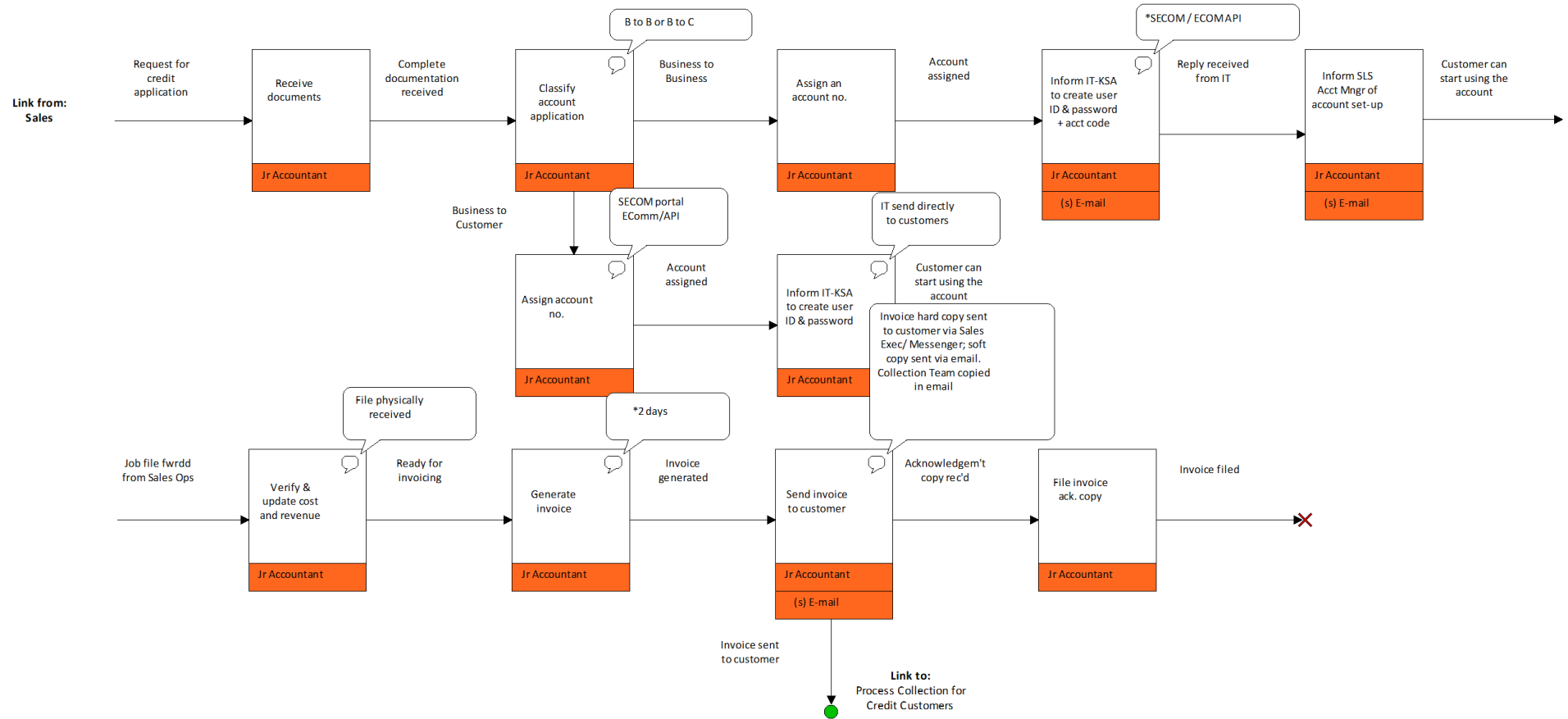

Title: Billing
 Author: Edwin Ramos
 Date: 4/26/2023
 Volume: 0.00 Per Second

Authorization: Update Pending
 Cost Per Second: \$,3.5,E-0317

Owner: Shaji George
 Diagram Version: Draft Copy
 Review Date: None
 F.T.E.: 0.00

- Actions
- Change Log
- Change Requests
- Feedback
- Keywords
- Read Only



Collections

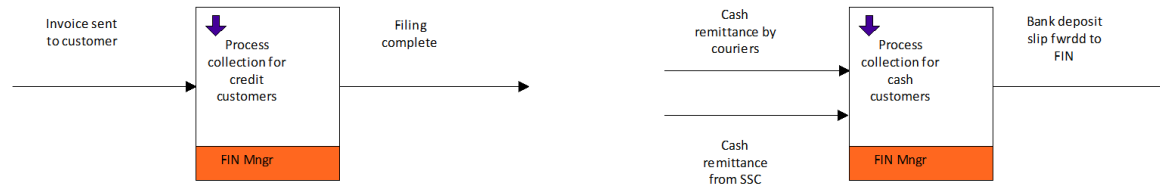

Title: Collections
Author: Edwin Ramos
Date: 4/26/2023
Volume: 0.00 Per Second

Authorization: Update Pending
Cost Per Second: \$,3.5,E-0317

Owner: Shaji George
Diagram Version: Draft Copy
Review Date: None
F.T.E.: 0.00

- Actions
- Change Log
- Change Requests
- Feedback
- Keywords
- Read Only



Process Collection for Credit Customers

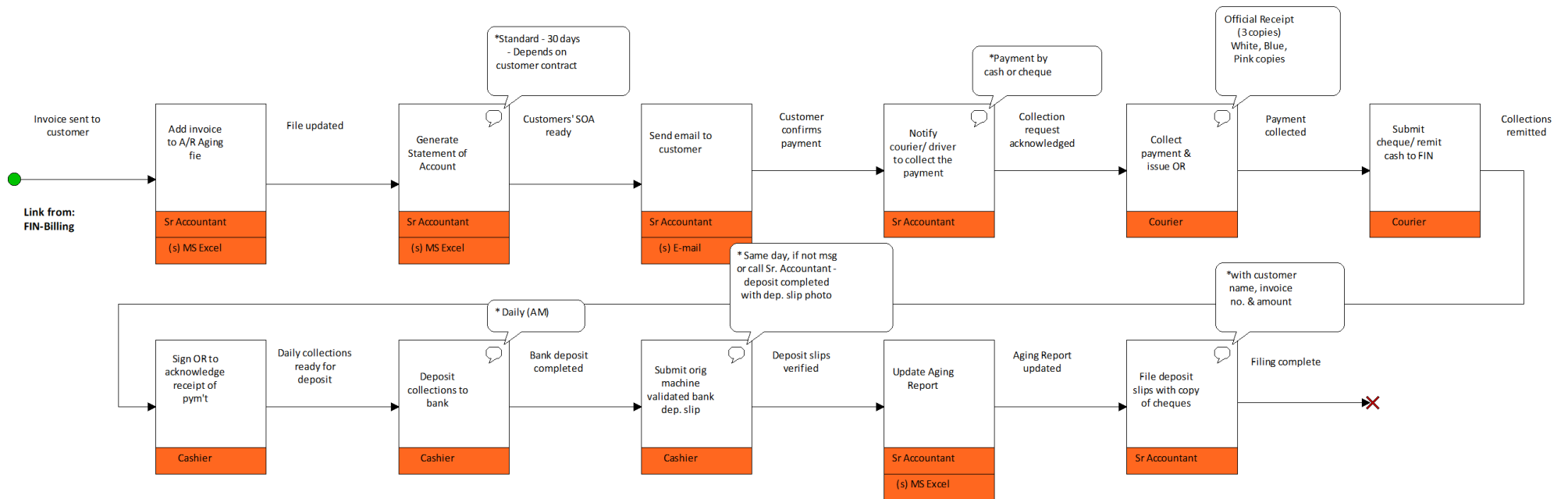

Title: Process Collection for Credit Customers
 Author: Edwin Ramos
 Date: 7/25/2024
 Volume: 0.00 Per Second
 Authorization: Update Pending
 Cost Per Second: \$,3.5,E-0317

Owner: Edwin Ramos
 Diagram Version: Draft Copy
 Review Date: None
 F.T.E.: 0.00

- Actions
- Change Log
- Change Requests
- Feedback
- Keywords
- Read Only



Process Collection for Cash Customers

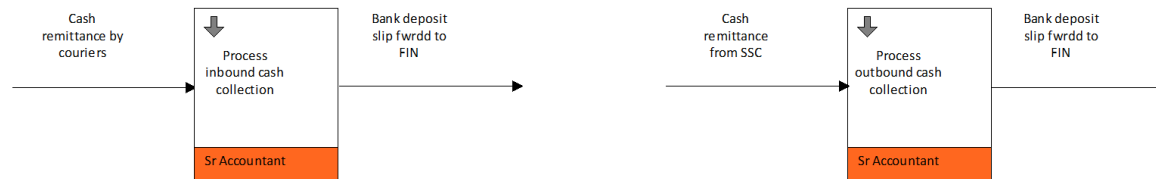



Process Outbound Cash Collection

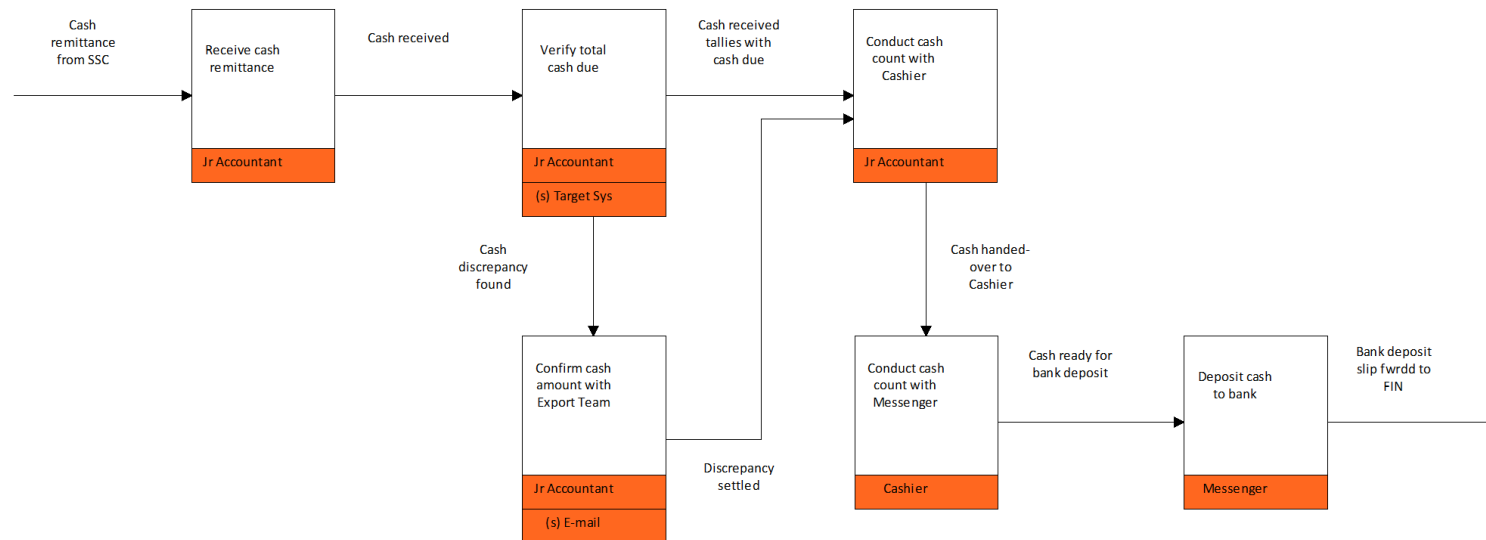

Title: Process Outbound Cash Collection
 Author: Edwin Ramos
 Date: 7/25/2024
 Volume: 0.00 Per Second
 Authorization: Update Pending
 Cost Per Second: \$,3.5,E-0317

Owner: Edwin Ramos
 Diagram Version: Draft Copy
 Review Date: None
 F.T.E.: 0.00

- Actions
- Change Log
- Change Requests
- Feedback
- Keywords
- Read Only



Process Inbound Cash Collection



Link to:
OPS - Station
Inbound
Process

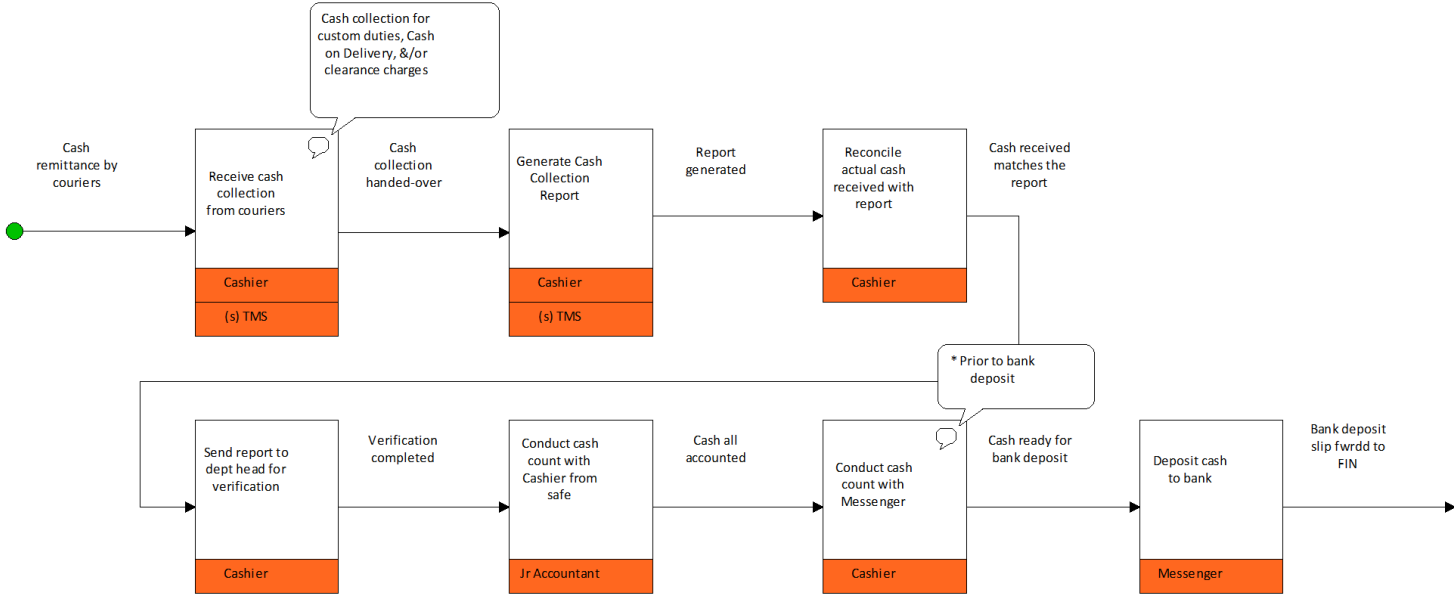



Payroll

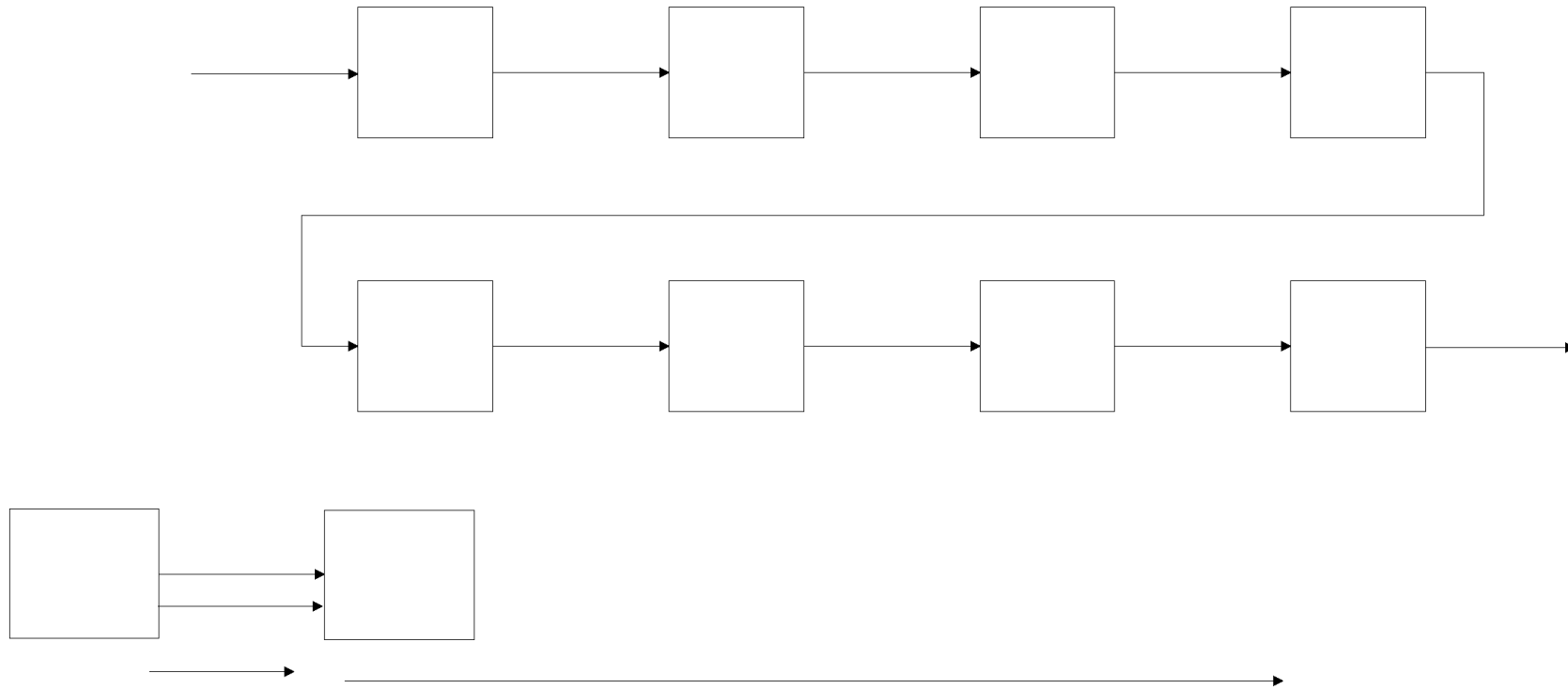

Title: Payroll
Author: Edwin Ramos
Date: 4/26/2023
Volume: 0.00 Per Second

Authorization: Update Pending
Cost Per Second: \$,3.5,E-0317

Owner: Shaji George
Diagram Version: Draft Copy
Review Date: None
F.T.E.: 0.00

- Actions
- Change Log
- Change Requests
- Feedback
- Keywords
- Read Only



Purchasing

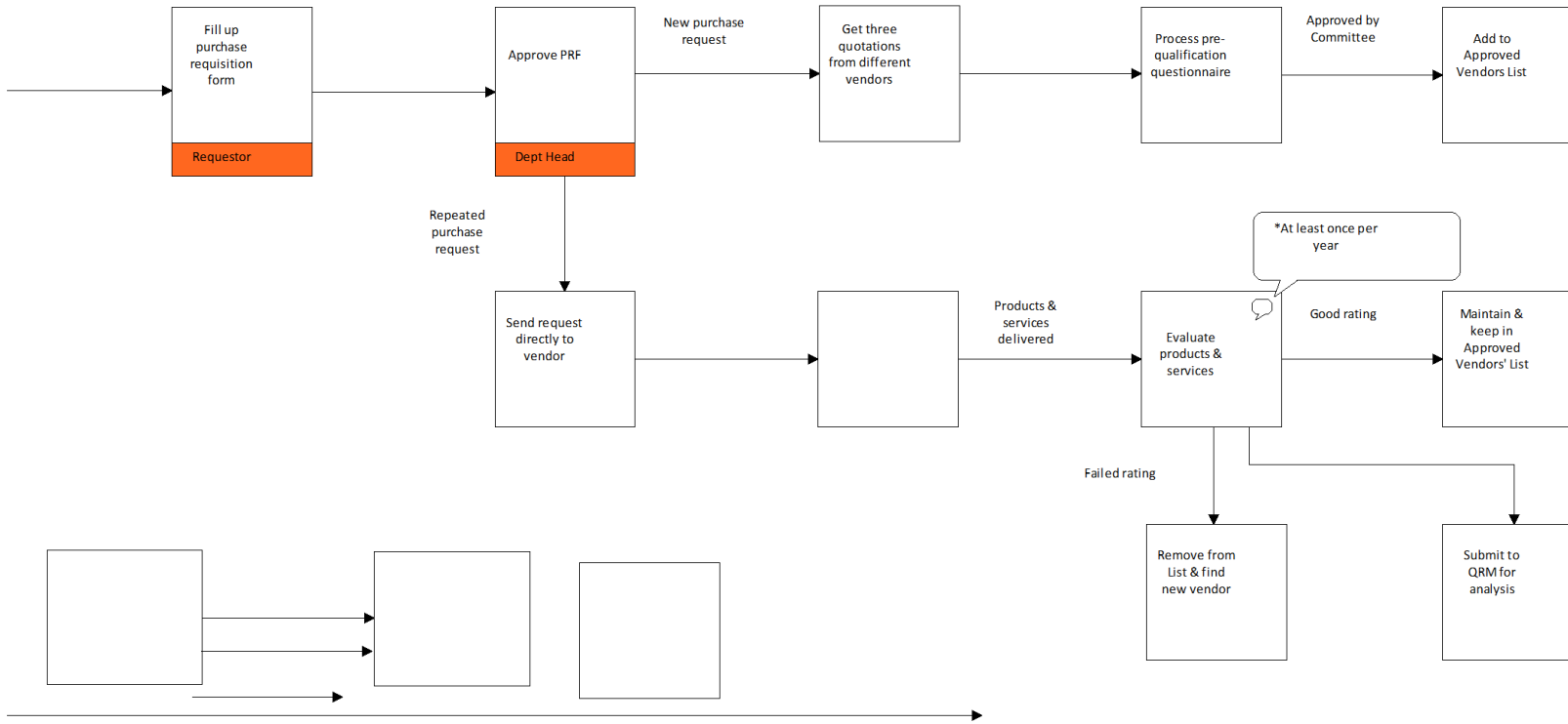



Kuwait - Information Technology

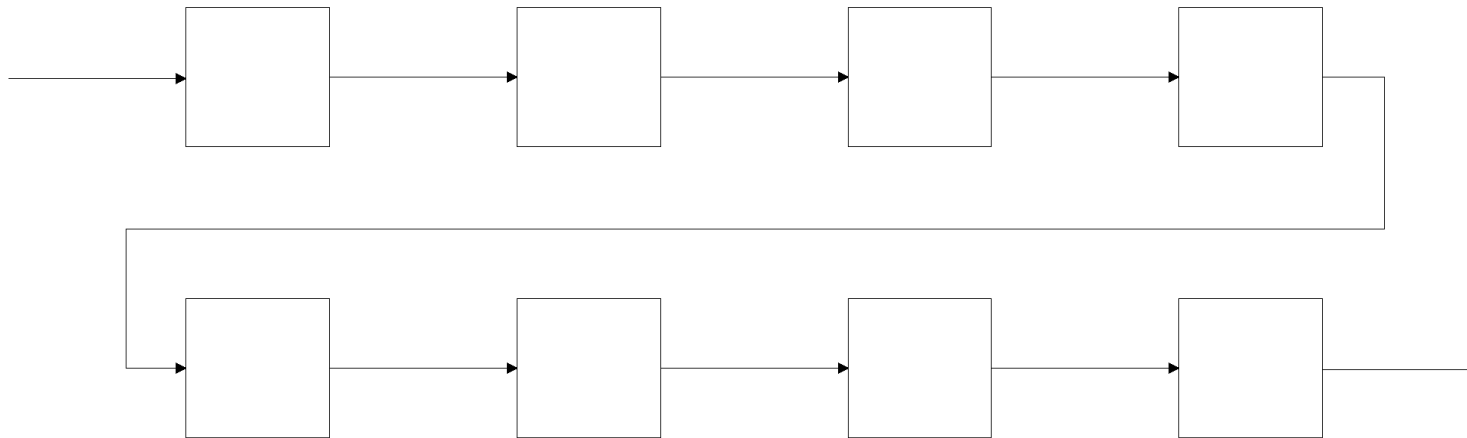



Kuwait - Corporate



ORG STRUCTURE

Title: Kuwait - Corporate
Author: Edwin Ramos
Date: 9/5/2023
Volume: 0.00 Per Second

Authorization: Update Pending
Cost Per Second: \$,3.5,E-0317

Owner: Shaji George
Diagram Version: Draft Copy
Review Date: None
F.T.E.: 0.00

Actions Feedback
 Change Log Keywords
 Change Requests Read Only



KWT - Organizational Chart

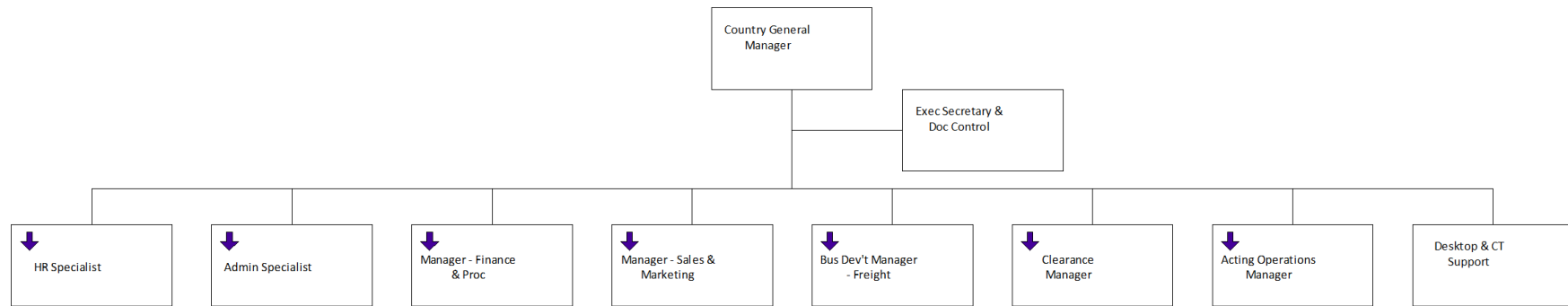

Title: KWT - Organizational Chart
Author: Edwin Ramos
Date: 9/5/2023
Volume: 0.00 Per Second

Authorization: Update Pending
Cost Per Second: \$,3.5,E-0317

Owner: Shaji George
Diagram Version: Draft Copy
Review Date: None
F.T.E.: 0.00

- Actions
- Change Log
- Change Requests
- Feedback
- Keywords
- Read Only



Sales & Customer Service

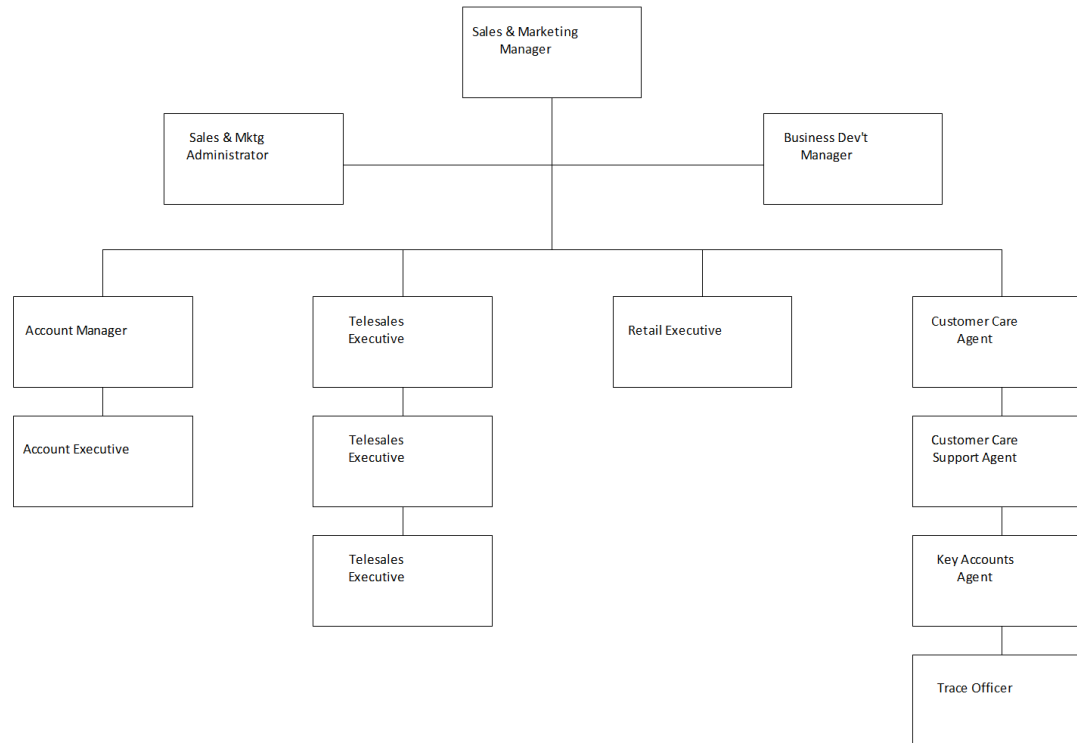

Title: Sales & Customer Service
Author: Edwin Ramos
Date: 9/5/2023
Volume: 0.00 Per Second

Authorization: Update Pending
Cost Per Second: \$,3.5,E-0317

Owner: Shaji George
Diagram Version: Draft Copy
Review Date: None
F.T.E.: 0.00

- Actions
- Change Log
- Change Requests
- Feedback
- Keywords
- Read Only



Business Dev't - Freight

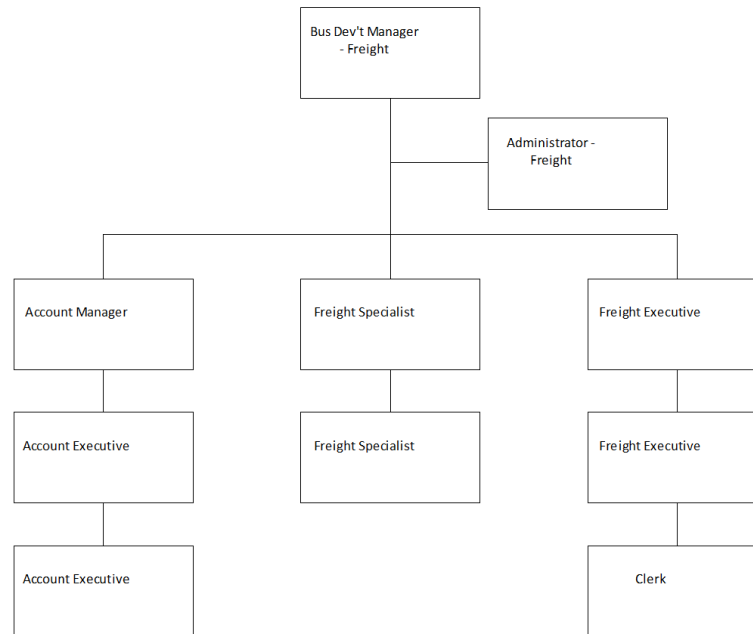

Title: Business Dev't - Freight
Author: Edwin Ramos
Date: 9/5/2023
Volume: 0.00 Per Second

Authorization: Update Pending
Cost Per Second: \$,3.5,E-0317

Owner: Shaji George
Diagram Version: Draft Copy
Review Date: None
F.T.E.: 0.00

- Actions
- Change Log
- Change Requests
- Feedback
- Keywords
- Read Only



Gateway

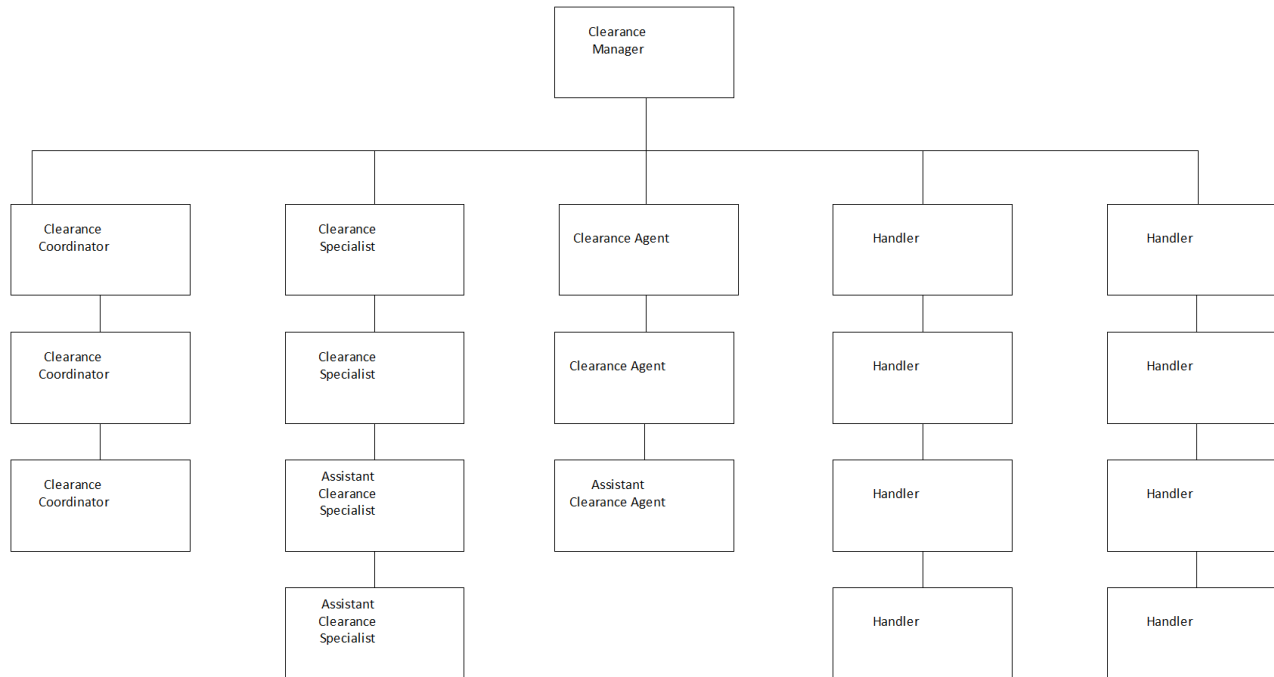

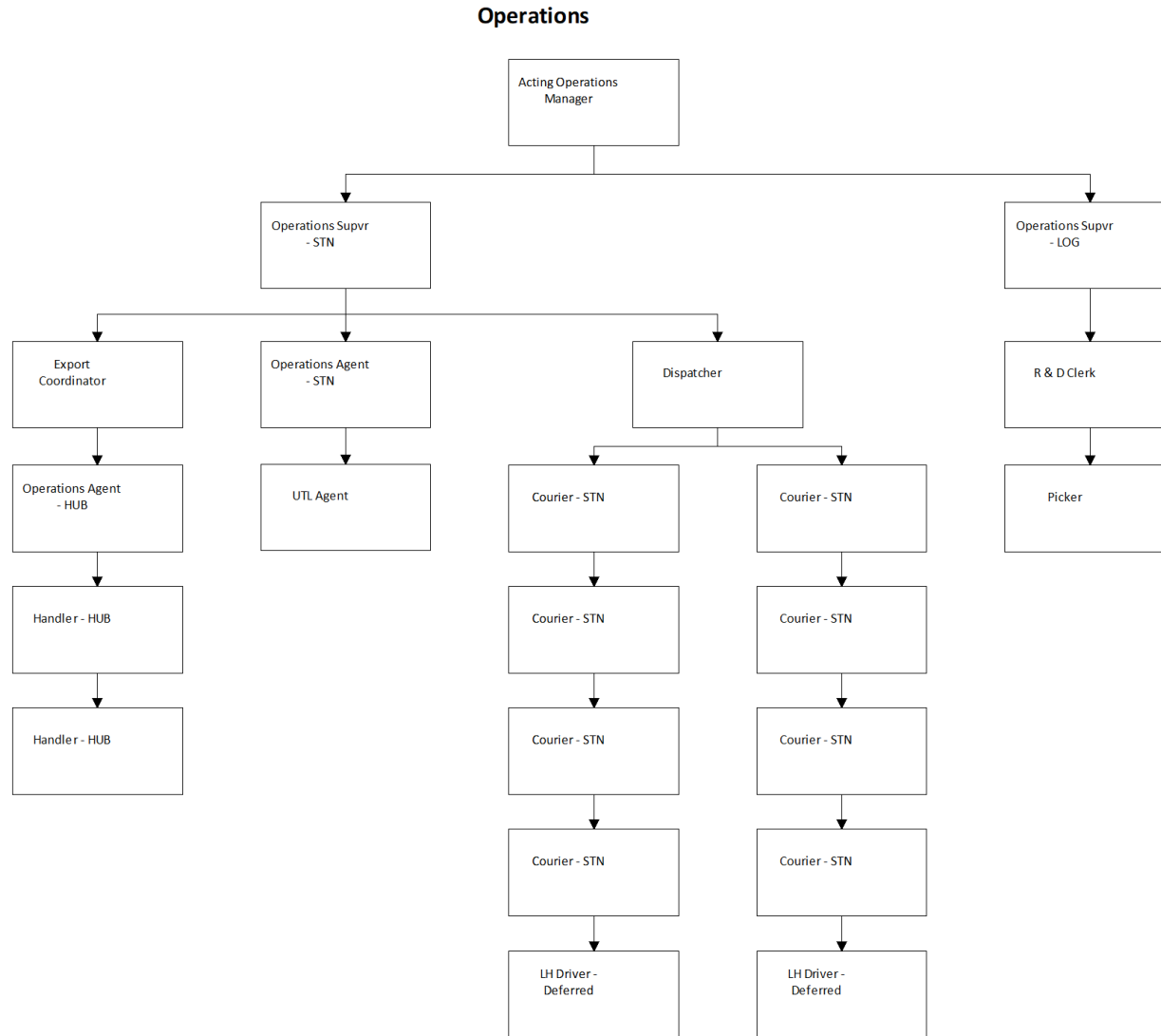



Finance & Procurement

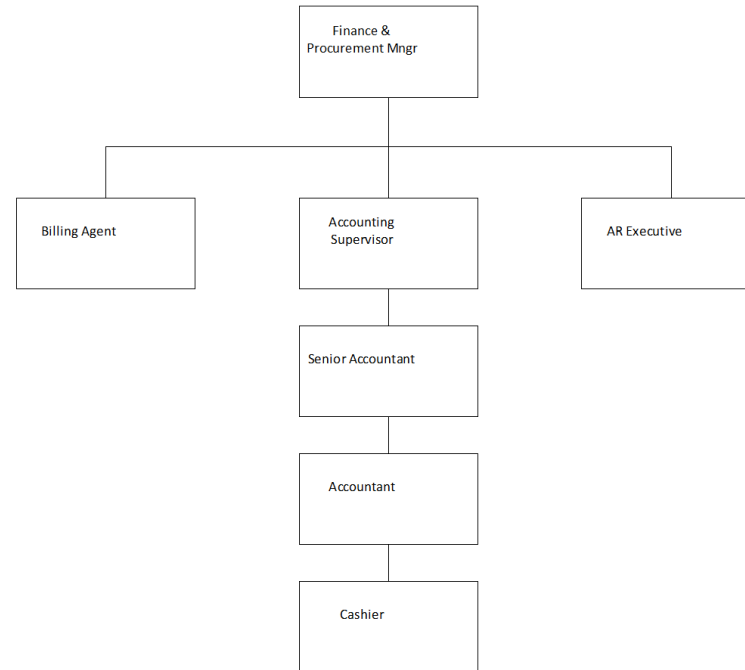

Title: Finance & Procurement
Author: Edwin Ramos
Date: 9/5/2023
Volume: 0.00 Per Second

Authorization: Update Pending
Cost Per Second: \$,3.5,E-0317

Owner: Shaji George
Diagram Version: Draft Copy
Review Date: None
F.T.E.: 0.00

- Actions
- Change Log
- Change Requests
- Feedback
- Keywords
- Read Only



Administration

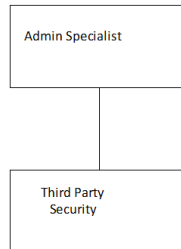

Title: Administration
Author: Edwin Ramos
Date: 2/15/2024
Volume: 0.00 Per Second

Authorization: Update Pending
Cost Per Second: \$,3.5,E-0317

Owner: Shaji George
Diagram Version: Draft Copy
Review Date: None
F.T.E.: 0.00

- Actions
- Change Log
- Change Requests
- Feedback
- Keywords
- Read Only



Human Resources

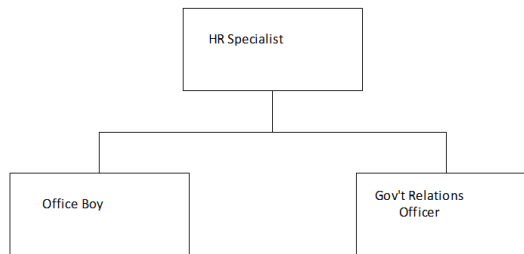

Title: Human Resources
Author: Edwin Ramos
Date: 9/5/2023
Volume: 0.00 Per Second

Authorization: Update Pending
Cost Per Second: \$,3.5,E-0317

Owner: Shaji George
Diagram Version: Draft Copy
Review Date: None
F.T.E.: 0.00

- Actions
- Change Log
- Change Requests
- Feedback
- Keywords
- Read Only